





## Straightening fitting for stabilizing 1215 to 2850 mm (3' 11 27/32" to 9' 4 7/32") high wooden doors (not suitable for hardwood)

### Product highlights

-  **Flexibility** The right solution for every application thanks to selectable heights and three different finish colors  
The tightening profile can be glued on or screwed on as required
-  **Comfort** The stable structure holds the doors in position and remains silent during operation

### Technical specifications

-  1215–2850 mm (3' 11 27/32" to 9' 4 7/32")
-  300–1600 mm (11 13/16" to 5' 3")
-  16–50 mm (5/8" to 1 31/32")

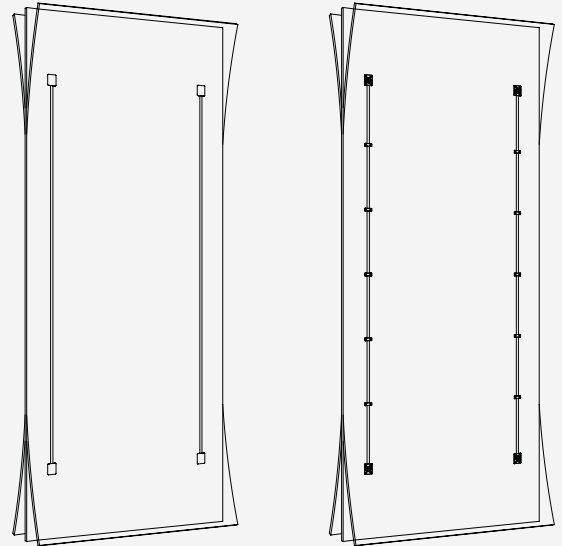



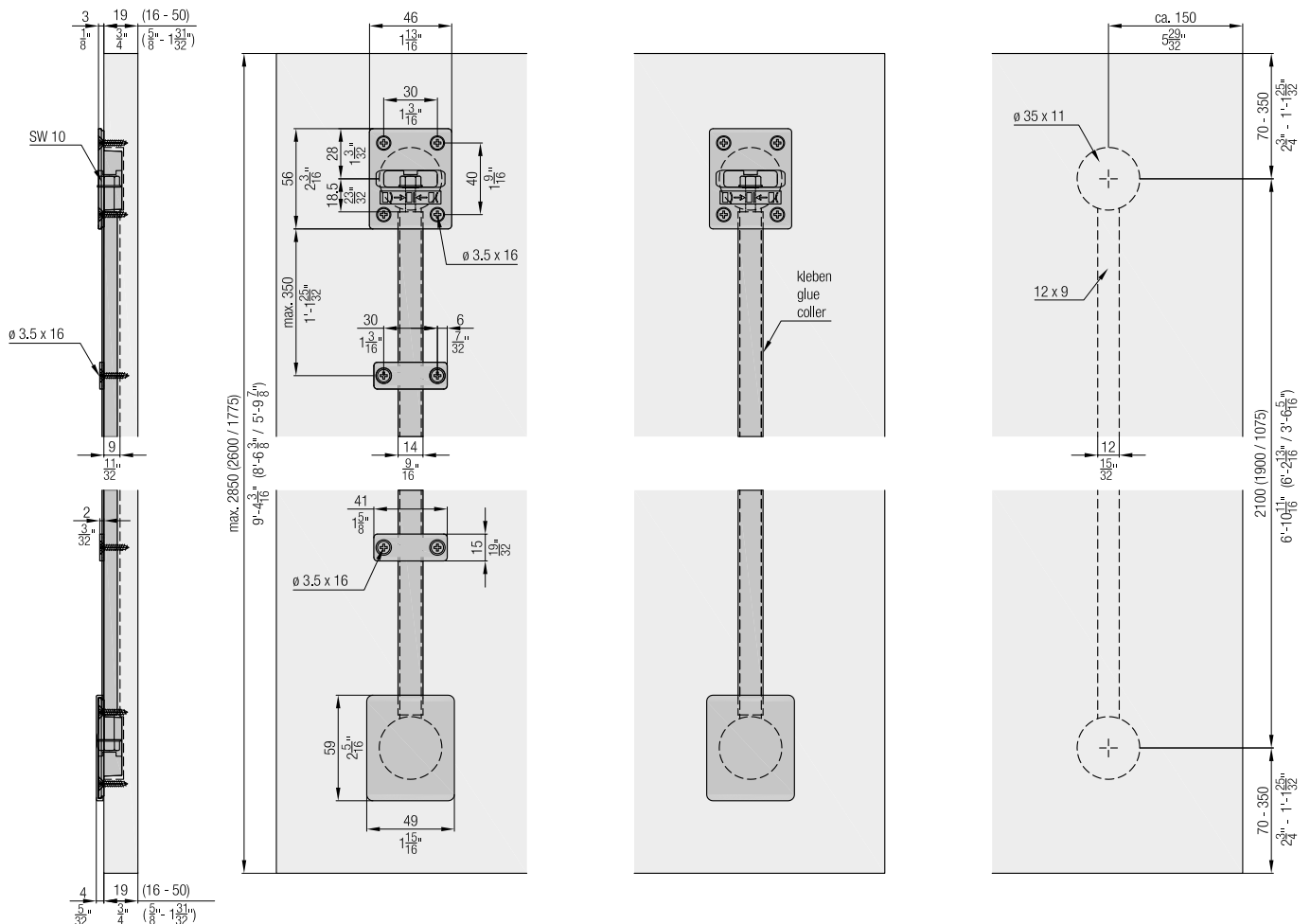



### Installation examples



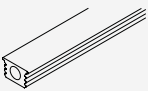

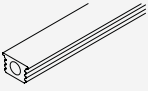
## Aluminum black anodized

	No.
Straightening fitting for doors 2240–2850 mm (7'4 3/16" to 9'4 7/32"), aluminum, black anodized	056.3192.074
Straightening fitting for doors 2040–2600 mm (6' 8 5/16" to 8' 6 3/8"), aluminum, black anodized	056.3192.075
Straightening fitting for doors 1715–2275 mm (5'7 15/32" to 7'5 9/16"), aluminum, black anodized	056.3192.081
Straightening fitting for doors 1215–1775 mm (3'11 27/32" to 5'9 7/8"), aluminum, black anodized	056.3192.076

Set consisting of:	056.3192.074	056.3192.075	056.3192.081	056.3192.076	No.
 Armature element, zinc alloy	4				056.0199.001
 Cover cap, plastic, black	4				056.0201.001
 Thread-cutting hexagon screw, M6x40 mm (1/4"x1 9/16"), steel, zinc-plated	4	4	4	4	056.0130.101
 Tightening profile, aluminum, black anodized, L= 2063 mm	2				056.0200.207
 Armature element, plastic, black		4	4	4	056.2024.001
 Tightening profile, aluminum, black anodized, L= 1863 mm (6' 1 11/32")		2			056.0200.187
 Tightening profile, aluminum, black anodized, L= 1038 mm (3' 4 7/8")				2	056.0200.104
 Tightening profile, aluminum, black anodized, L= 1538 mm (5' 9/16")			2		056.0200.188

## Accessories

	No.
 Cover cap, plastic, black, set of 4 pieces	056.0201.071
 Bracket, plastic, black, set of 10 pieces	056.0118.004

### Ordering information

– Type and number of sets

### Optional ordering information

– Number of cover caps  
– Number of brackets

### Planning/execution

All straightening fittings can be shortened to the required dimension.

Installation instructions No. 788.2000.314 have to be used for planning and execution. Further information about the product can be found on [www.hawa.com](http://www.hawa.com).