

<sup>®</sup>  
**MITM**  
80  
**0**

Ruota adatta per letti, tavoli e complementi d'arredo. Supporto in nylon, ruota in nylon con fascia in gomma poliuretanicca antimacchia adatta tutti i tipi di pavimentazione. Disco in ABS in varie colorazioni, possibilità disco lucido cromato. Freno in nylon stabilizzato. Versione libera o con freno a pedale.

Wheel designed for beds, tables and furniture accessories. Support in nylon, wheel in nylon with tyre in thermoplastic rubber suitable for all types of flooring. Disc in ABS in various colours or high gloss chrome. Brake in stabilized nylon. Free rotation or with pedal brake.

**DUO180**

HERBERT H.SCHULTES

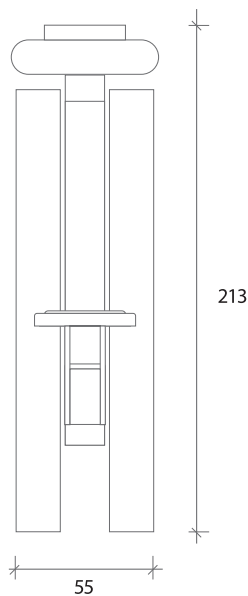
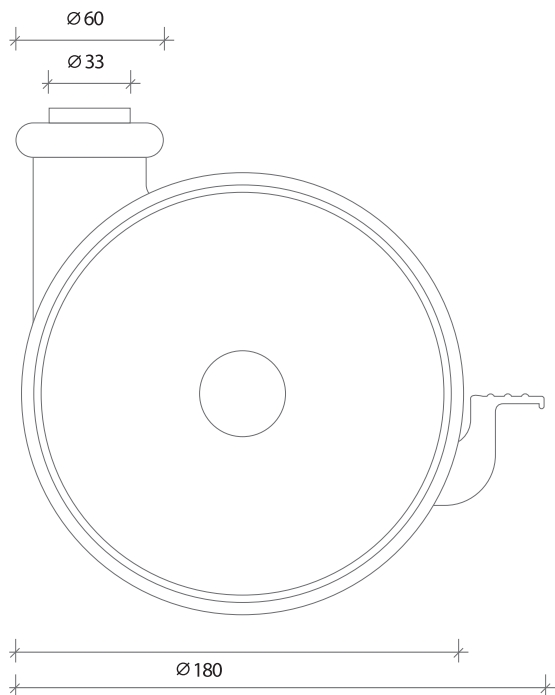

**DUO180**  
 PATENT  
**Portata utile 80 Kg.**  
**Capacity 80 Kg.**



215

**Standard**

Alluminio  
 Aluminium

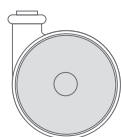

Bianco D.01  
 White D.01

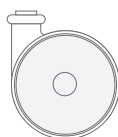

Grigio D.03  
 Grey D.03

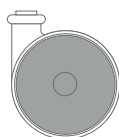

Gomme  
 Rubber

Grigio D.03  
 Grey D.03

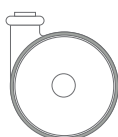

**Optional**

D. Acero  
 D. Maple

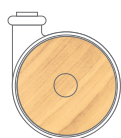

D. Ciliegio  
 D. Cherry

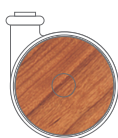

D. Faggio  
 D. Beech

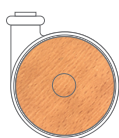

D. Noce  
 D. Walnut

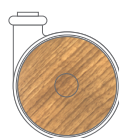

Wengè  
 Wengè

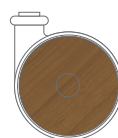

Rovere Sbiancato  
 Bleached Oak

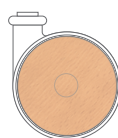

Neutro Trasp.  
 Neuter Trasp.

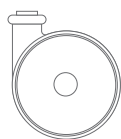

Rosso Trasp.  
 Red Trasp.

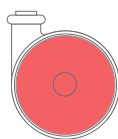

Verde Trasp.  
 Green Trasp.

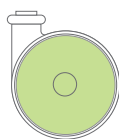

Giallo Trasp.  
 Yellow Trasp.

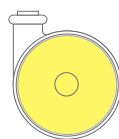

Arancio Trasp.  
 Orange Trasp.

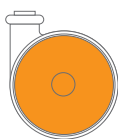

Blu Trasp.  
 Blue Trasp.

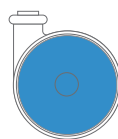

**Indicazioni per il fissaggio - Fastening indications**

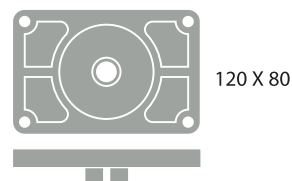

Attacco a piastra per  
 supporto unidirezionale  
 Plate attachment moving  
 only one direction

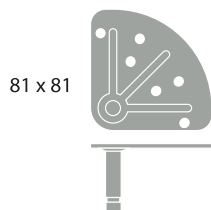

Attacco a piastra per  
 supporto girevole H 216  
 Rotating plate attachment H 216

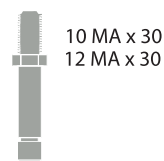

Perno filettato  
 Threaded pivot