



DOMUS Line®

SMALLY XS COLLECTION



About us

DOMUS Line is an Italian company specialized in the designing and production of lighting devices for the furniture industry.

Six brands put together the widest offer of lighting systems and control devices of the furniture lighting sector.

Ongoing research, innovation, design, reliability and brand reputation are the distinctive values of our company.



Luminaires for kitchens, living rooms and bedrooms



Architectural luminaires for bathrooms



Luminaires for classic furniture



Commercial lighting



Luminaires UL and CSA approved for USA and Canada



Sensors and LED converters

Quality, environment and safety



The international standard ISO 9001 outlines the way to achieve high performance by following processes that improve operational efficiency at all levels. ISO 9001 is the most popular standard in the world, because it ensures the quality of processes, providing organizations with a competitive advantage. DOMUS Line has been ISO9001 certified for many years and has entrusted an entity among the most prestigious in the world to carry out periodic checks.



The international standard ISO 14001 is a management system recognized around the world that provides a framework for managing environmental performance. This standard is designed to help companies maintain high business value and, at the same time, effectively manage environmental responsibility. The recent certification of DOMUS Line ensures the company's commitment to continuous improvement and respect for the environment.



The ETL brand (Electrical Testing Laboratories) indicates that the product has been tested in accordance with the applicable product standards (ANSI, UL, CSA, ASTM, NFPA) so as to be sold in North America. DOMUS Line offers a wide range of products certified according to this standard, and then traded in compliance with the law in USA and Canada.



TECHNICAL DATA

Power supply	12Vdc
Wattage	3W
Wiring	2000mm
Connector	Micro12

Device with non-replaceable LED module
 Energy efficiency class: A++, A+, A
 EU Regulation No. 874/2012

PHOTOMETRIC DATA

Colour appearance	natural white
Colour temperature	4300 K
Luminous flux	390 lm
Luminous efficiency	130 lm/W
CRI	Ra ≥80

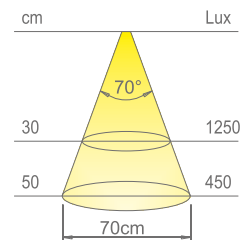

Colour appearance	warm white
Colour temperature	3000 K
Luminous flux	360 lm
Luminous efficiency	120 lm/W
CRI	Ra ≥80

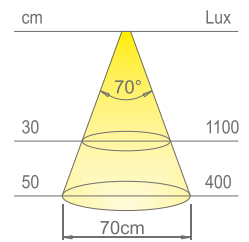
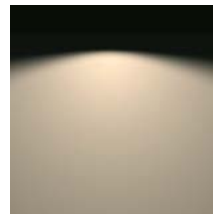

Colour appearance	super warm white
Colour temperature	2700 K
Luminous flux	360 lm
Luminous efficiency	120 lm/W
CRI	Ra ≥80

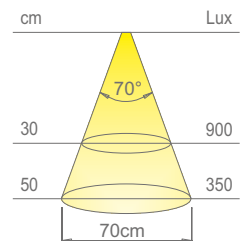

FINISHES



WHITE



STEEL



ALUMINIUM



SATIN NICKEL



CHROME PLATED

SMALLY XS Plus

with PLUG & PLAY SYSTEM

The SMALLY XS Plus configuration is equipped with the innovative Plug&Play system. Thanks to this innovation the power cord can be easily unplugged from the spotlight.

This makes installation easier and at the same time allows for easy unplugging and removal of the fitting even when already fixed to the furniture.



SMALLY XS IP44

SMALLY XS has IP44 protection and is therefore protected against splashes of water. SMALLY XS can be installed even in humid environments, such as bathrooms in complete safety.





FIVE DEC
Losguarda
Pictures of the Times
A century of photography from The New York
MININGO - ROBERT FRANK
Losguarda sulla bellezza



No point effect technology

All the luminaires of the SMALLY XS collection have a homogeneous and diffused light projection and devoid of the speckled effect typical of traditional LED spotlights. The SMALLY XS collection also integrates a special optics, which appear neutral and uniform even when the appliance is off.





SMALLY XS is a LED diffused lighting appliance designed for flush mounting with a 57mm hole and an installation depth of only 12mm. SMALLY XS is installed in wooden panels with both through and blind hole. The fixing system, with two lateral steel springs, is quick and does not require any tools. Its essential design makes it a versatile spotlight, ideal for installation inside wall units, under wall cabinets or under shelves, and in all the environments of the house.



SMALLY XS SP is designed for surface installation without the need for planned and complex holes in the furniture. Assembly is achieved by simply mounting the spacer with the two supplied screws, to which the spotlight is then fixed by pressing lightly. The simplicity of this fitting system allows a quick and simple installation of the luminaire under shelves in the kitchen, living room or bathroom.



SMALLY XS OB has a particular inclined shape at 20° and is easily installed on the surface flush with the vertical wall, allowing the cable of the appliance to be easily concealed behind the cabinet. Its asymmetrical light projection makes SMALLY XS OB ideal for installation under wall units in the kitchen to illuminate the worktop.



The EVOSMALLY XS, MENFI XS, TIKAL XS, HANAN XS and KISH XS collections integrate the LED technology of SMALLY XS PLUS and are made with high quality stainless steel bases for surface installation.

Ideal for application under kitchen wall units, they light the worktop excellently.

All the models are installed flush against the wall with the power cable hidden behind the cabinet. An on-off switch can be integrated, for the centralized control of a set of fixtures.



EVOSMALLY XS

LED luminaire with PLUG & PLAY system.
Symmetrical light projection.



with on/off switch



slave



MENFI XS

LED luminaire with PLUG & PLAY system.
Asymmetrical light projection.



with on/off switch



slave



TIKAL XS

LED luminaire with PLUG & PLAY system.
Symmetrical light projection.



with on/off switch



slave



HANAN XS

LED luminaire with PLUG & PLAY system.
Asymmetrical light projection.



with on/off switch



slave



KISH XS

LED luminaire with PLUG & PLAY system.
Asymmetrical light projection.



with on/off switch

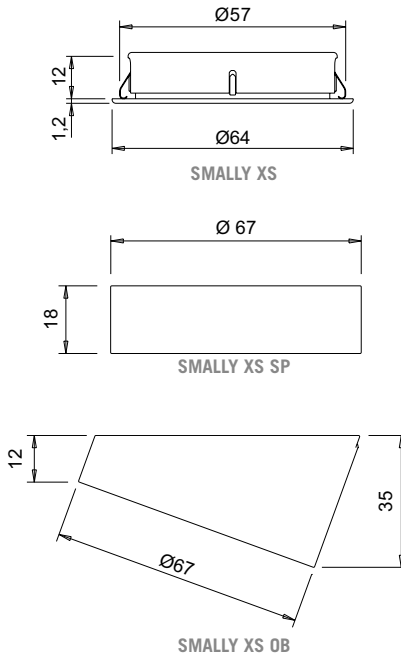

slave

SMALLY XS PLUS (IP20)

Code	Model	Watt @ Volt
12310_**	recessed	3W @ 12Vdc
12270_**	SP	3W @ 12Vdc
12271_**	OB	3W @ 12Vdc

SET SMALLY XS PLUS - converter included



Code	Model	Watt @ Volt
22227_**	set 3X recessed	9W @ 230Vac
22229_**	set 3X SP	9W @ 230Vac
22231_**	set 3 XOB	9W @ 230Vac
22228_**	set 5X recessed	9W @ 230Vac
22230_**	set 5X SP	9W @ 230Vac
22232_**	set 5X OB	9W @ 230Vac

SMALLY XS IP44

Code	Model	Watt @ Volt
12266_**P	recessed	3W @ 12Vdc
12267_**P	SP	3W @ 12Vdc
12268_**P	OB	3W @ 12Vdc

SET SMALLY XS IP44 - converter included

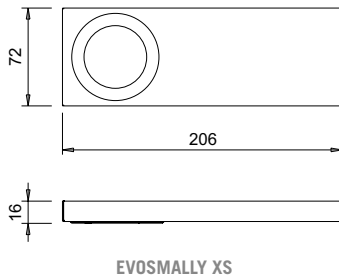
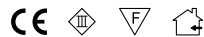

Code	Model	Watt @ Volt
22220_**P	set 3X recessed	9W @ 230Vac
22223_**P	set 3X SP	9W @ 230Vac
22225_**P	set 3 XOB	9W @ 230Vac
22221_**P	set 5X recessed	9W @ 230Vac
22224_**P	set 5X SP	9W @ 230Vac
22226_**P	set 5X OB	9W @ 230Vac

EXOSMALLY XS PLUS

Code	Model	Watt @ Volt
1231216_**	slave	3W @ 12Vdc
1227316_**	with switch	3W @ 12Vdc

SET EXOSMALLY XS PLUS - converter included

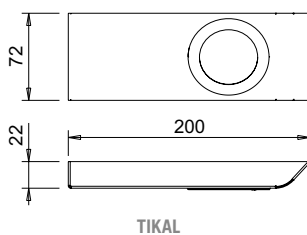
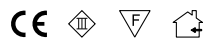

Code	Model	Watt @ Volt
2218616_**	set 3X IG	9W @ 230 Vac
2218716_**	set 5X IG	9W @ 230 Vac

TIKAL XS PLUS

Code	Model	Watt @ Volt
1235416_**	slave	3W @ 12Vdc
1235516_**	with switch	3W @ 12Vdc

SET TIKAL XS PLUS - converter included

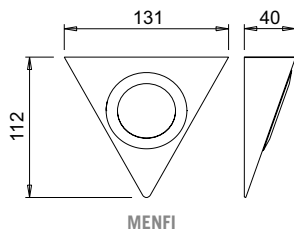
Code	Model	Watt @ Volt
2224516_**	set 3X IG	9W @ 230 Vac
2224616_**	set 5X IG	9W @ 230 Vac



MENFI

MENFI XS PLUS

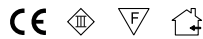

Code	Model	Watt @ Volt
1226416_**	slave	3W @ 12Vdc
1227216_**	with switch	3W @ 12Vdc

SET MENFI XS PLUS - converter included



Code	Model	Watt @ Volt
2220016_**	set 3X IG	9W @ 230 Vac
2220116_**	set 5X IG	9W @ 230 Vac

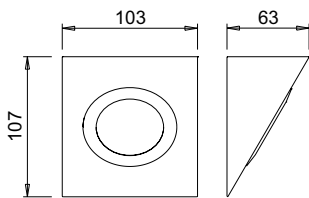

KISH

KISH XS PLUS

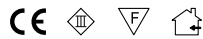

Code	Model	Watt @ Volt
1235616_**	slave	3W @ 12Vdc
1235516_**	with switch	3W @ 12Vdc

SET KISH XS PLUS - converter included



Code	Model	Watt @ Volt
2224516_**	set 3X IG	9W @ 230 Vac
2224616_**	set 5X IG	9W @ 230 Vac

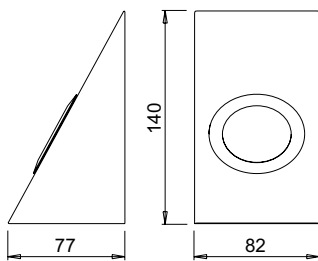

HANAN

HANAN XS PLUS

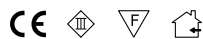

Code	Model	Watt @ Volt
1235816_**	slave	3W @ 12Vdc
1235916_**	with switch	3W @ 12Vdc

SET HANAN XS PLUS - converter included



Code	Model	Watt @ Volt
2224916_**	set 3X IG	9W @ 230 Vac
2225016_**	set 5X IG	9W @ 230 Vac

* Please add the colour finish

01	white
09	chrome plated
10	aluminium
17	satin nickel
19	steel

**Please add the light colour

N	natural white
B	warm white
B1	super warm white

MICRO12 - looking ahead

DOMUS Line has always been very careful about all of the accessories used in its wide range of lighting devices. The wiring, and especially the connection between the converter and the luminaire, is crucial for the correct function of a lighting fixture.

Balanced wiring and a perfect connection guarantee great performance and reduce the risk of faults and working anomalies.



**MICRO12 - SAFER, SMARTER
AND BETTER CONNECTED
LIGHTING SYSTEMS**

INNOVATIVE CONNECTORS WITH SNAP-IN RETENTION FOR SIMPLE AND FAST INSTALLATION

The entire SMALLY XS collection comes as standard with the new Micro12 connection system. A new family of efficient connectors that gives great versatility of connection. The new Micro12 solution is very efficient and will be the technology of the future.

SUGGESTED NEW CONVERTERS

SL6/12R

CE □ ▽ ⊕ SELV 🏠

Code	Input	Output	Power	Input wiring	Output wiring
0852401	220 - 240Vac	12Vdc	0,5 - 6W	2000mm with Europlug	500mm with Micro12 distributor 10 connections

FLAT 15/12R

CE □ ▽ ⊕ SELV 🏠

Code	Input	Output	Power	Input wiring	Output wiring
0852501	220 - 240Vac	12Vdc	1 - 15W	2000mm with Europlug	500mm with Micro12 distributor 10 connection

SL30/12R

CE □ ▽ ⊕ SELV 🏠

Code	Input	Output	Power	Input wiring	Output wiring
0852601	220 - 240Vac	12Vdc	3 - 30W	2000mm with Europlug	500mm with Micro12 distributor 10 connection

SL60/12R

CE □ ▽ ⊕ SELV 🏠

Code	Input	Output	Power	Input wiring	Output wiring
0851701	220 - 240Vac	12Vdc	2 - 60W	2000mm with Europlug	500mm with Micro12 distributor 10 connection

Warranty

Each unit is fully guaranteed for a period of 24 months from the date of delivery. From the warranty are excluded all defects caused by force majeure (lightning, fire, etc..), as well as any damage caused by improper use of equipment. The products must be installed and/or used in accordance with the specifications and instructions given by DOMUS Line Srl. They must also be installed and/or used in compliance with the provisions governing the installation and/or use of electric material force in the country where the products are installed and/or used. To this end, the buyer expressly releases DOMUS Line Srl from any responsibility for improper use, failure to comply with safety standards, technical specifications and instructions for use. The products which do not meet the standards and/or specifications in force in the European Union, will only be provided to the buyer that in the order specifies that the destination country does not belong to the European Union and indicating to have exhausted all the controls on compatibility of safety standards in force in the country outside the EU for which they are intended. In the absence of other arrangements for testing of the equipment, the standards established by the CEI (Italian Electrotechnical Committee) are valid. The warranty is void without fail in the event of tampering with the equipment by persons or technicians not specifically authorized by DOMUS Line Srl. The warranty does not cover normal wear and tear or the consequences of improper installation, nor the failure and/or breaks caused by inexperience and/or neglect.

Copyright

© 2015 DOMUS Line®

The brand and name DOMUS Line are registered trademarks. DOMUS Line owns brand names and known and widely used logos. The brand names and logos published in this catalogue are registered or in any case subject to the laws on unregistered brand names. All reproduction or distribution by any means: photocopies, internet, microfilm or other means, total or partial, of this catalogue is forbidden without the written permission of DOMUS Line.

Patents

The patented models, registered and published in this catalogue, are protected and counterfeiting will be prosecuted in accordance with the law.

Disclaimer

This document is distributed as “uncontrolled” and DOMUS Line reserves the right to change the characteristics of the products to meet any technical or commercial needs, without prior notice. DOMUS Line verified the data published in this document with the utmost attention. However, because of the variables that exist between the development process and the publication of the catalogue, DOMUS Line assumes no responsibility for errors, gaps in data, inaccuracies, and so on.



DOMUS Line®

DOMUS Line srl

Via Maestri del Lavoro, 1 I-33080 Porcia (PN) Italy

P. +39 0434 595911 F. +39 0434 923345

info@domusline.com

www.domusline.com