

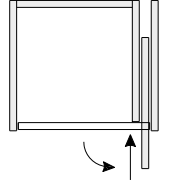

**Components required for one cabinet**

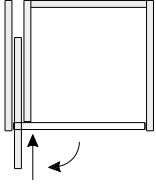

**Hawa Concepta III 35 Pull, left**

	No.
Hawa Concepta III 35, basic set left, door height 1900–2700 mm (6' 2 13/16" to 8' 10 5/16")	30996
Hawa Concepta III 25/35, Pull slide-in set, left	31000
Upright profile L= 2474 mm (8' 1 13/32"), for door height 1900–2700 mm (6' 2 13/16" to 8' 10 5/16"), aluminum, anodized	30771

**Hawa Concepta III 35 Pull, right**

	No.
Hawa Concepta III 35, basic set right, door height 1900–2700 mm (6' 2 13/16" to 8' 10 5/16")	30997
Hawa Concepta III 25/35, Pull slide-in set, right	31001
Upright profile L= 2474 mm (8' 1 13/32"), for door height 1900–2700 mm (6' 2 13/16" to 8' 10 5/16"), aluminum, anodized	30771

**Weight and door size ratio calculations**

The maximum weight must be adapted depending on the door size ratio.

DE Türbreite / FR Largeur de porte / EN Door width / IT Larghezza anta / ES Ancho de puerta

	440	500	550	600	650	700	750
2700	35	35	35	35	35	35	35
2650	35	35	35	35	35	35	35
2600	35	35	35	35	35	35	35
2550	35	35	35	35	35	35	35
2500	35	35	35	35	35	35	35
2450	35	35	35	35	35	35	34
2400	35	35	35	35	35	35	33
2350	35	35	35	35	35	34	32
2300	35	35	35	35	35	34	31
2250	35	35	35	35	35	33	31
2200	35	35	35	35	34	32	30
2150	35	35	35	35	33	31	29
2100	35	35	35	35	32	30	28
2050	35	35	35	34	31	29	27
2000	35	35	35	33	30	28	26
1950	35	35	35	32	29	27	26
1900	35	35	34	31	29	27	25

DE Türgewicht in kg / FR Poids de porte en kg / EN Door weight in kg / IT Peso anta in kg / ES Peso de puerta en kg

	1' 5 5/16"	1' 7 11/16"	1' 9 21/32"	1' 11 5/8"	2' 1 19/32"	2' 3 9/16"	2' 5 17/32"
8' 10 5/16"	77	77	77	77	77	77	77
8' 8 11/32"	77	77	77	77	77	77	77
8' 6 3/8"	77	77	77	77	77	77	77
8' 4 13/32"	77	77	77	77	77	77	77
8' 2 7/16"	77	77	77	77	77	77	77
8' 0 15/32"	77	77	77	77	77	77	75
7' 10 1/2"	77	77	77	77	77	77	73
7' 8 17/32"	77	77	77	77	77	75	71
7' 6 9/16"	77	77	77	77	77	75	68
7' 4 19/32"	77	77	77	77	77	73	68
7' 2 5/8"	77	77	77	77	75	71	66
7' 0 21/32"	77	77	77	77	73	68	64
6' 10 11/16"	77	77	77	77	71	66	62
6' 8 23/32"	77	77	77	75	68	64	60
6' 6 3/4"	77	77	77	73	66	62	57
6' 4 25/32"	77	77	77	71	64	60	57
6' 2 13/16"	77	77	75	68	64	60	55

DE Türgewicht in lbs. / FR Poids de porte en lbs. / EN Door weight in lbs. / IT Peso anta in lbs. / ES Peso de puerta en lbs.

DE Maximale Gewichte in kg / FR Poids maximale en kg / EN Maximum weights in kg / IT Pesi massimo in kg / ES Pesos máximos en kg













DE Maximale Gewichte in lbs. / FR Poids maximale en lbs. / EN Maximum weights in lbs. / IT Pesi massimo in lbs. / ES Pesos máximos en lbs.

**Hawa Configurator**

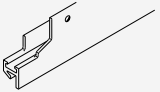
**List of individual parts, which are included in the sets:**



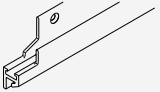



**Set for 1 pivot /slide-in door up to 35 kg (77 lbs.)**

	No.
Hawa Concepta III 35, basic set left, door height 1900–2700 mm (6' 2 13/16" to 8' 10 5/16")	30996
Hawa Concepta III 35, basic set right, door height 1900–2700 mm (6' 2 13/16" to 8' 10 5/16")	30997

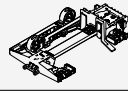
	30996	30997	No.
<b>Set consisting of:</b>			
 Slot nuts for hinge attachment, plastic, black	4	4	30686
 Mounting plate for hinge with height adjustment, steel, nickel-plated	1	1	30738
 Concealed hinge, with soft closing mechanism and closing spring, steel, nickel plated	4	4	31070
 Set for concealed hinges, 8 screws 4x16 mm (5/32"x5/8"), 3 door stop buffers	1	1	30811
 Profile for magnetic guide, with double-sided adhesive tape, steel, black, L=730 mm (2' 4 3/4")	2	2	30983
 Euro screw, 6x13 mm (1/4"x1/2"), steel, black, set of 6 pieces	1	1	30986
 Bottom guide track left, aluminum, anodized, L= 838 mm (2' 9")	1		30805
 Top running track left, aluminum, anodized, L= 838 mm (2' 9")	1		31059
 Countersunk head screw, 4.5x20 mm (5/32"x25/32"), steel, zinc-plated, set of 16 pieces	1	1	30810
 Set of adjusting tools	1	1	31047
 Bottom guide track right, aluminum, anodized, L= 838 mm (2' 9")		1	30806
 Top running track right, aluminum, anodized, L= 838 mm (2' 9")		1	31060

**Suitable slide-in set**

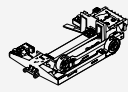
	No.
Hawa Concepta III 25/35, Pull slide-in set, left	31000
Hawa Concepta III 25/35, Pull slide-in set, right	31001

	31000	31001	No.
<b>Set consisting of:</b>			
 Hawa Concepta III 25/35 Pull slide-in unit, left	1		31040
 End stop bracket Pull, steel zinc-plated	1	1	31414
 Soft closing mechanism with end stop	1	1	31221
 Hawa Concepta III Pull set of cover caps, for left-hand stop, plastic, black	1		30964
 Hawa Concepta III 25/35 Pull slide-in unit, right		1	31041
 Hawa Concepta III Pull set of cover caps, for right-hand stop, plastic, black		1	30965

**Cabinet connecting parts**

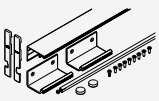
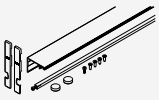
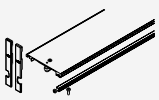
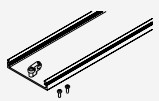
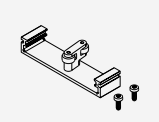
		mm (inch)	No.
	Connector set 55 mm (2 5/32"), for exterior connection to cabinet	560 (1' 10 1/16")	31005
	Connector top 55 mm (2 5/32"), for exterior connection to cabinet	560 (1' 10 1/16")	31430
	Connector top 110 mm (4 11/32"), for two pivot/slide-in doors	500 (1' 7 11/16")	31006
	Connector bottom 110 mm (4 11/32"), for two pivot/slide-in doors	500 (1' 7 11/16")	31246
	Connector bottom 110 mm (4 11/32"), for two pivot/slide-in doors (for installation in front of fixed plinth)	26 (1 1/32")	31007

**Guides**

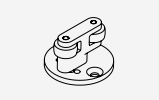
	No.
	25680

**Accessories**

	No.
	31020

**Straightening fitting, aluminum**

→ Details from page 266

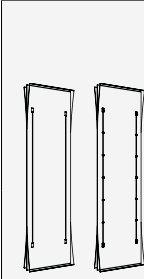
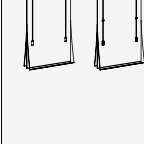
	No.
	056.3192.071
	056.3192.072

**Straightening fitting, aluminum, black anodized**

→ Details from page 266

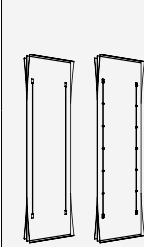
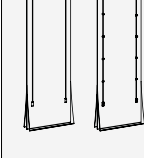
	No.
	056.3192.074
	056.3192.075

**Straightening fitting**

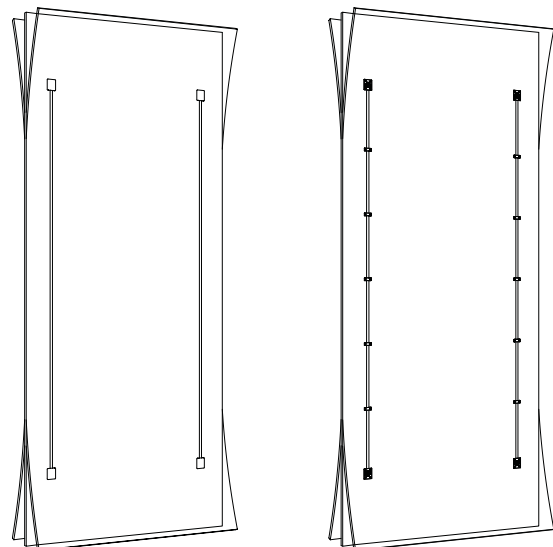

Further installation examples  
Composed cabinet

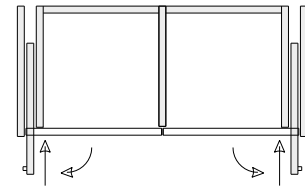
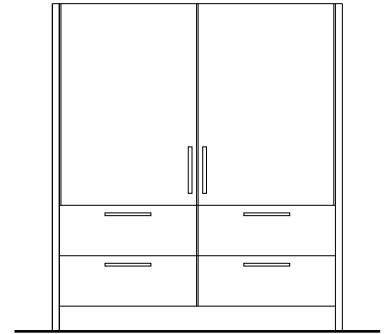
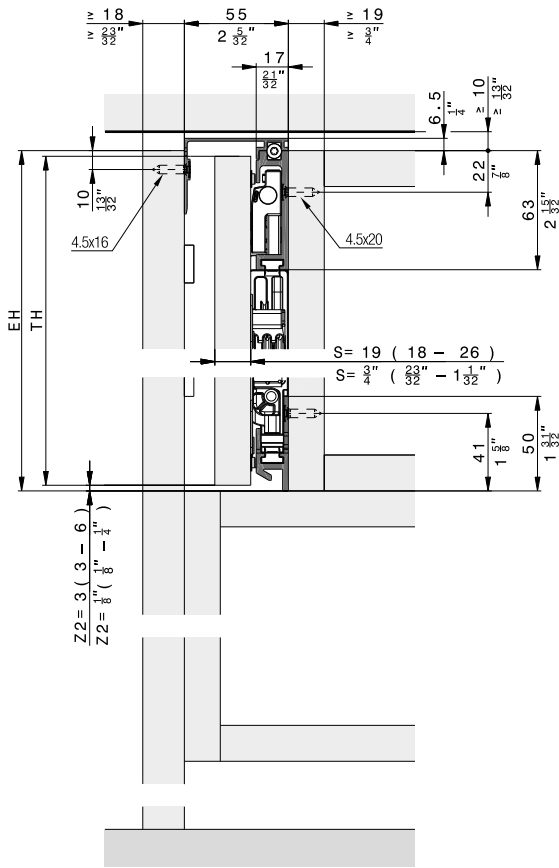

Cabinet without base panel

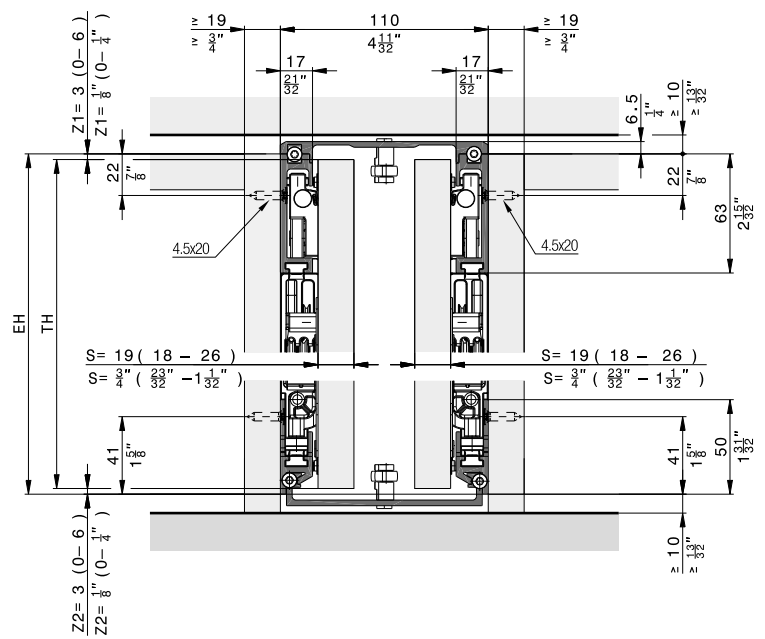
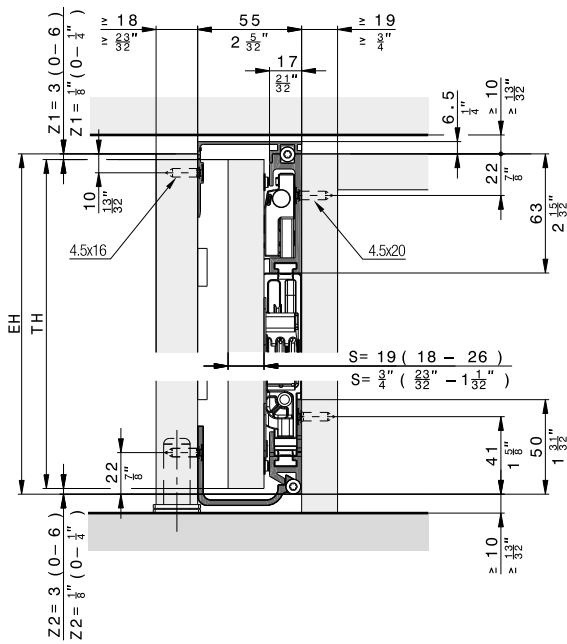



Hardware depth calculation

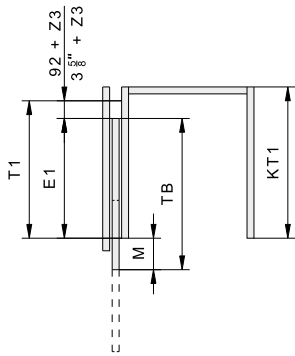

	mm	Inch
T1	≥ 414	≥ 1' 4 <sup>5</sup> / <sub>16</sub> ''

	mm	Inch
T1	TB + 92 + Z3 - M	TB + 3 <sup>5</sup> / <sub>8</sub> '' + Z3 - M
E1	TB - M	TB - M
M	≥ S + 3 ≤ TB - 320	≥ S + <sup>5</sup> / <sub>8</sub> '' ≤ TB - 1 <sup>19</sup> / <sub>32</sub> ''

Door flush with outer face

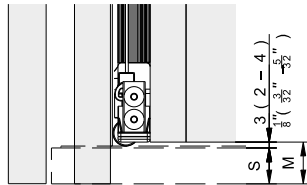

Protruding door

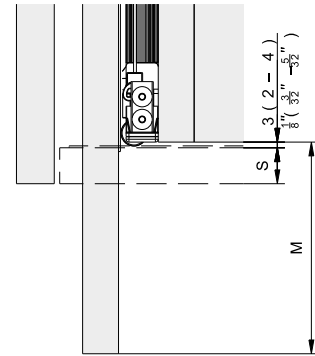

Instructions

Videos

Accessories

– Straightening fitting from page 266

Planning/execution

Configure with just a few clicks at [www.hawa.com/configurator](http://www.hawa.com/configurator)

Further information about the product can be found on [www.hawa.com](http://www.hawa.com).