

TAVINEA SORTO FOR NOVA PRO

Interior accessory system



- Perfect organisation for cutlery and small items
- High-quality frames and divider rails made of powder-coated steel
- Colour-coordinated
- Innovative anti-slip device ensures firm seating on the base panel

Packaging unit (PU):

201 = 1 unit in a cardboard box
207 = 10 units in a cardboard box

Notes:

- Tavinea Sorto B186 can be used with cabinet widths from 300
- Tavinea Sorto B276 can be used with cabinet widths from 400

ORDER INFORMATION

1 Tavinea Sorto B186
Single item



NL	Stone			Silver								
	Art.-no.	PU		Art.-no.	PU							
350	F007130074	201		F007130075	201							
400	F007130078	201		F007130079	201							
450	F007130082	201		F007130083	201							
500	F007130086	201		F007130087	201							
550	F007130090	201		F007130091	201							
600	F007130094	201		F007130095	201							
650	F007130098	201		F007130099	201							

2 Tavinea Sorto B276
Single item



NL	Stone			Silver								
	Art.-no.	PU		Art.-no.	PU							
400	F007130050	201		F007130051	201							
450	F007130054	201		F007130055	201							
500	F007130058	201		F007130059	201							
550	F007130062	201		F007130063	201							
600	F007130066	201		F007130067	201							
650	F007130070	201		F007130071	201							

3 Tavinea Sorto divider rail
Single item



NL	Stone			Silver								
	Art.-no.	PU		Art.-no.	PU							
350	F007130102	207		F007130103	207							
400	F007130106	207		F007130107	207							
450	F007130110	207		F007130111	207							
500	F007130114	207		F007130115	207							
550	F007130118	207		F007130119	207							
600	F007130122	207		F007130123	207							
650	F007130126	207		F007130127	207							

PAGE REFERENCES

Accessories	8
Installation information	10

1 Tavinea Sorto B186

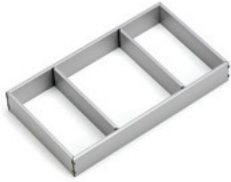

NL 350



NL 400 - 500

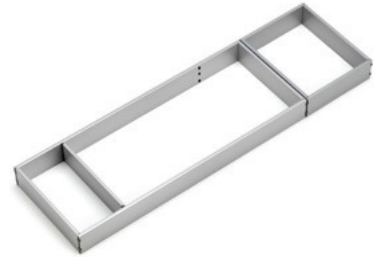

NL 550 - 650

2 Tavinea Sorto B276



NL 400



NL 450 - 500



NL 550 - 650

3 Tavinea Sorto divider rail



Tavinea Sorto accessories see page 8

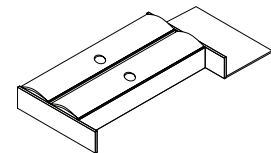
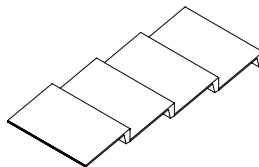
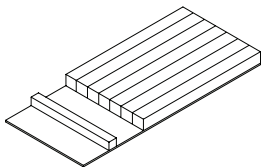

LEGEND

B Width
KB Cabinet width
NL Nominal length

TAVINEA SORTO FOR NOVA PRO

Accessories



- The right accessories for all requirements
- Knives, spice jars, cooking foil, cutlery or Eau de Toilette – with Tavinea Sorto accessories, everything has its perfect place
- High-quality materials: Aluminium and solid wood

Packaging unit (PU):

201 = 1 unit in a cardboard box

Note:

Accessories are hygiene-tested and non-toxic

ORDER INFORMATION

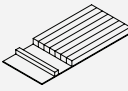
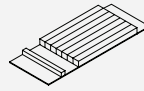
1 Knife block Single item						
	NL 450	PU	NL 500	PU	NL 550 ¹	PU
Light ash	F007108657	201	F007101990	201	F007101990 F007108659	201
Dark ash	F007108658	201	F007101995	201	F007101995 F007108660	201

¹ NL 550 comprises a knife block and levelling element. Please order both article numbers.

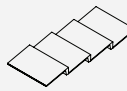
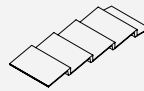
2 Spice rack Single item				
	NL 500	PU	NL 550 ¹	PU
Light ash	F007101992	201	F007101992 F007108659	201
Dark ash	F007101997	201	F007101997 F007108660	201

¹ NL 550 comprises a spice rack and levelling element. Please order both article numbers.

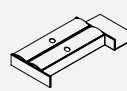
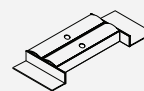
3 Foil holder Single item				
	NL 500	PU	NL 550 ¹	PU
Light ash	F007101994	201	F007101994 F007108659	201
Dark ash	F007101999	201	F007101999 F007108660	201

¹ NL 550 comprises a foil holder and levelling element. Please order both article numbers.

PAGE REFERENCES

Tavinea Sorto	6
Installation information	10

1 Knife block

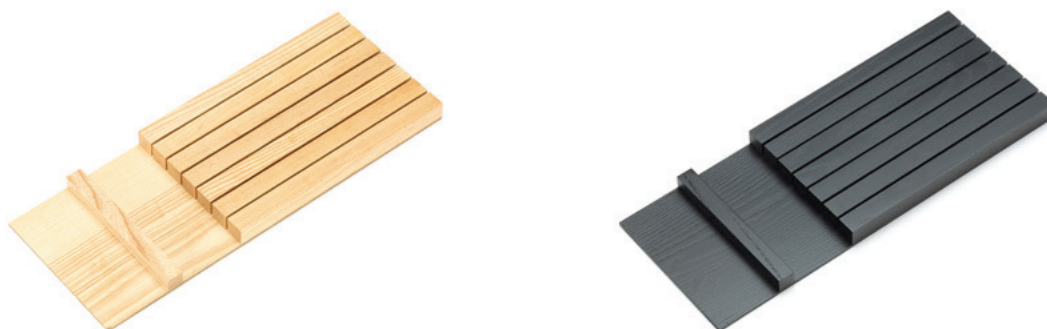

2 Spice rack



3 Foil holder



LEGEND

NL Nominal length

TAVINEA SORTO FOR NOVA PRO

Installation information

APPLICATION EXAMPLES

KB 450

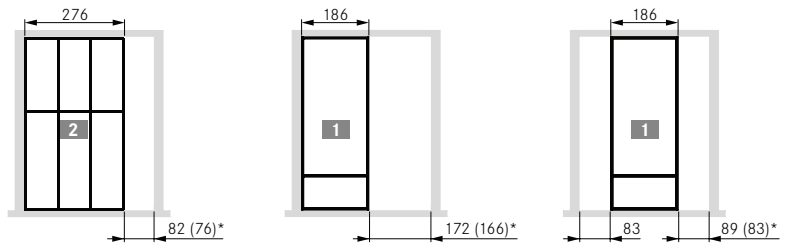
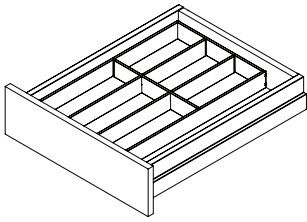

KB 600

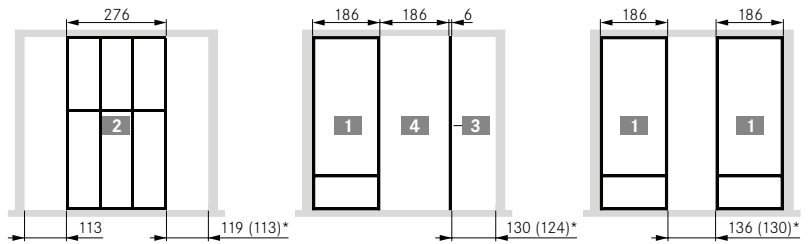
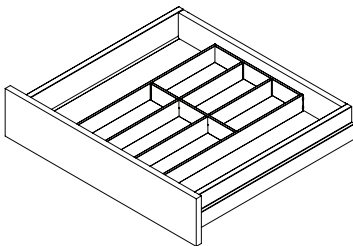

KB 900

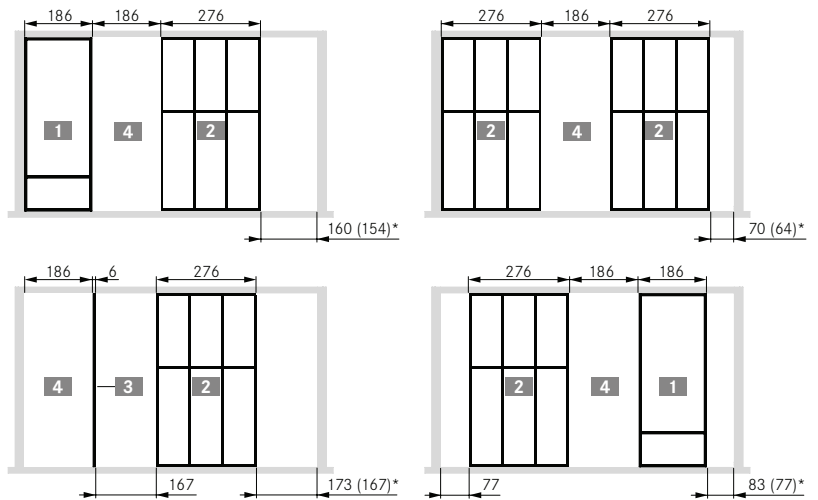
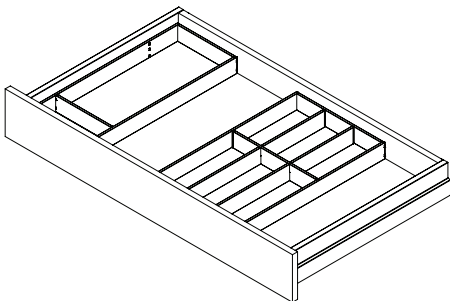

KB 1200

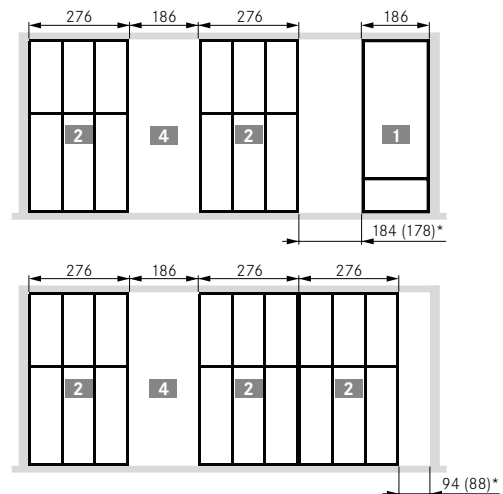
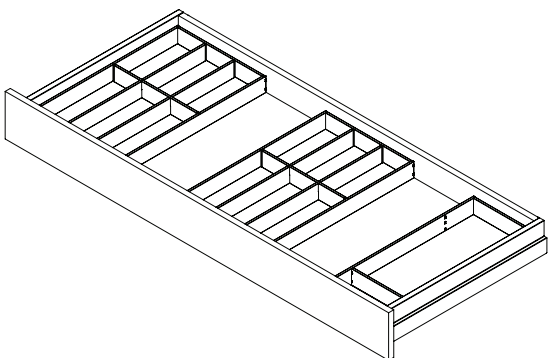

* S16 (S18/S19)

APPLICATION EXAMPLE

Description

1

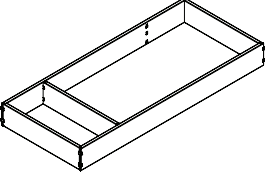

2

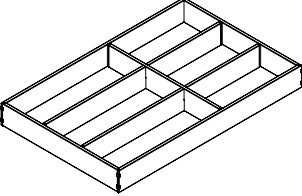

3

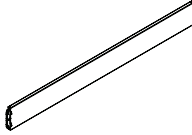

4

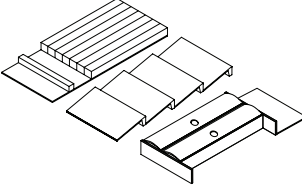

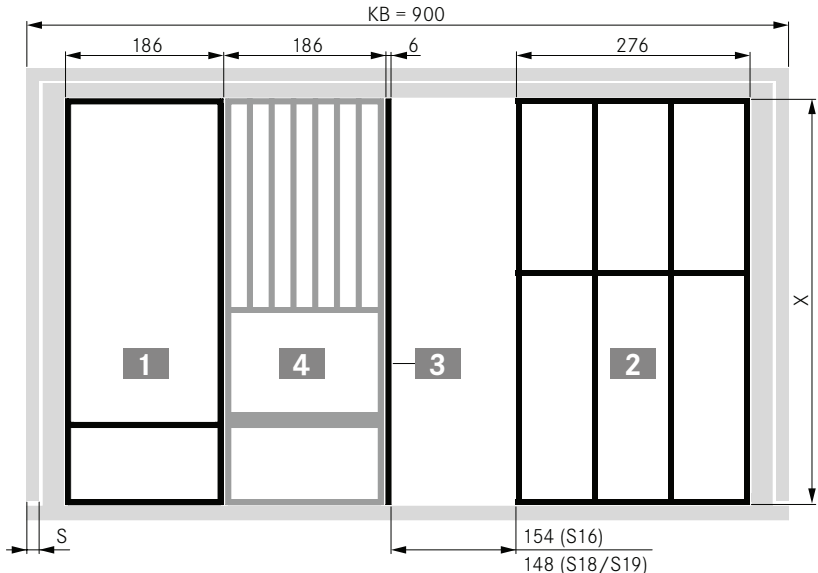

NL	X
350	329
400	379
450	429
500	479
550	530
600	580
650	630

INSTALLATION INFORMATION

Description

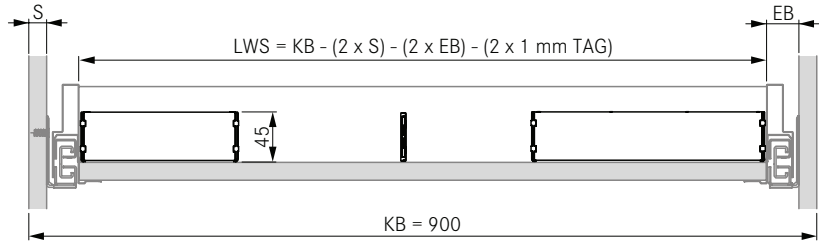

S/EB	External cabinet width (KB)										
	300	400	500	600	700	800	900	1000	1100	1200	
16/29	208	308	408	508	608	708	808	908	1008	1108	
18/30	202	302	402	502	602	702	802	902	1002	1102	
19/29	202	302	402	502	602	702	802	902	1002	1102	
Internal dimension (LWS)											

LEGEND

EB	Construction width	S	Cabinet side wall	
KB	Cabinet width	TAG	Tolerance compensation	
LWS	Clear drawer width			
NL	Nominal length			