

TAVINEA SORTO FOR NOVA PRO

Interior accessory system



- Perfect organisation for cutlery and small items
- High-quality frames and divider rails made of powder-coated steel
- Colour-coordinated
- Innovative anti-slip device ensures firm seating on the base panel

Packaging unit (PU):

201 = 1 unit in a cardboard box
207 = 10 units in a cardboard box

Notes:

- Tavinea Sorto B186 can be used with cabinet widths from 300
- Tavinea Sorto B276 can be used with cabinet widths from 400

ORDER INFORMATION

1 Tavinea Sorto B186 Single item												
												
NL	Stone				Silver							
	Art.-no.	PU			Art.-no.	PU						
350	F007130074	201			F007130075	201						
400	F007130078	201			F007130079	201						
450	F007130082	201			F007130083	201						
500	F007130086	201			F007130087	201						
550	F007130090	201			F007130091	201						
600	F007130094	201			F007130095	201						
650	F007130098	201			F007130099	201						

2 Tavinea Sorto B276 Single item												
												
NL	Stone				Silver							
	Art.-no.	PU			Art.-no.	PU						
400	F007130050	201			F007130051	201						
450	F007130054	201			F007130055	201						
500	F007130058	201			F007130059	201						
550	F007130062	201			F007130063	201						
600	F007130066	201			F007130067	201						
650	F007130070	201			F007130071	201						

3 Tavinea Sorto divider rail Single item												
												
NL	Stone				Silver							
	Art.-no.	PU			Art.-no.	PU						
350	F007130102	207			F007130103	207						
400	F007130106	207			F007130107	207						
450	F007130110	207			F007130111	207						
500	F007130114	207			F007130115	207						
550	F007130118	207			F007130119	207						
600	F007130122	207			F007130123	207						
650	F007130126	207			F007130127	207						

PAGE REFERENCES

Accessories	8
Installation information	10

1 Tavinea Sorto B186



NL 350



NL 400 - 500



NL 550 - 650

2 Tavinea Sorto B276



NL 400

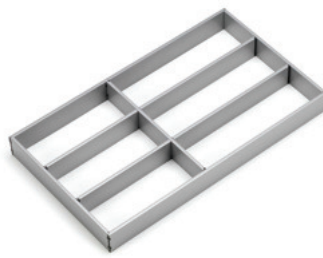

NL 450 - 500



NL 550 - 650

3 Tavinea Sorto divider rail



Tavinea Sorto accessories see page 8

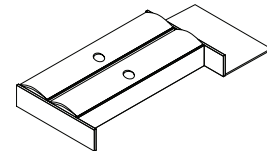
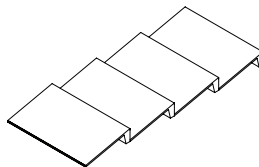
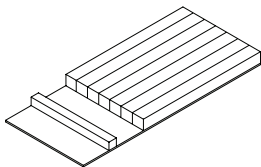

LEGEND

B Width
KB Cabinet width
NL Nominal length

TAVINEA SORTO FOR NOVA PRO

Accessories



- The right accessories for all requirements
- Knives, spice jars, cooking foil, cutlery or Eau de Toilette – with Tavinea Sorto accessories, everything has its perfect place
- High-quality materials: Aluminium and solid wood

Packaging unit (PU):

201 = 1 unit in a cardboard box

Note:

Accessories are hygiene-tested and non-toxic

ORDER INFORMATION

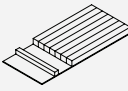
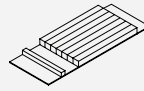
1 Knife block Single item						
	NL 450	PU	NL 500	PU	NL 550 ¹	PU
Light ash	F007108657	201	F007101990	201	F007101990	201
Dark ash	F007108658	201	F007101995	201	F007101995	201
					F007108660	

¹ NL 550 comprises a knife block and levelling element. Please order both article numbers.

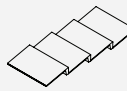
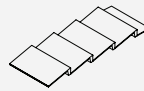
2 Spice rack Single item				
	NL 500	PU	NL 550 ¹	PU
Light ash	F007101992	201	F007101992	201
Dark ash	F007101997	201	F007101997	201
			F007108660	

¹ NL 550 comprises a spice rack and levelling element. Please order both article numbers.

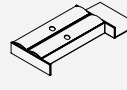
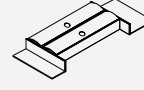
3 Foil holder Single item				
	NL 500	PU	NL 550 ¹	PU
Light ash	F007101994	201	F007101994	201
Dark ash	F007101999	201	F007101999	201
			F007108660	

¹ NL 550 comprises a foil holder and levelling element. Please order both article numbers.

PAGE REFERENCES

Tavinea Sorto	6
Installation information	10

1 Knife block



2 Spice rack



3 Foil holder



LEGEND

NL Nominal length

TAVINEA SORTO FOR NOVA PRO

Installation information

APPLICATION EXAMPLES

KB 450

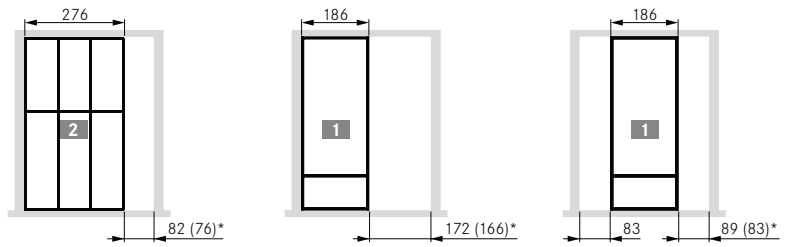
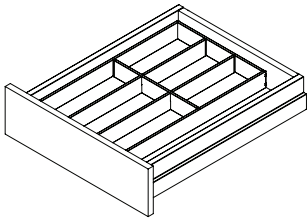

KB 600

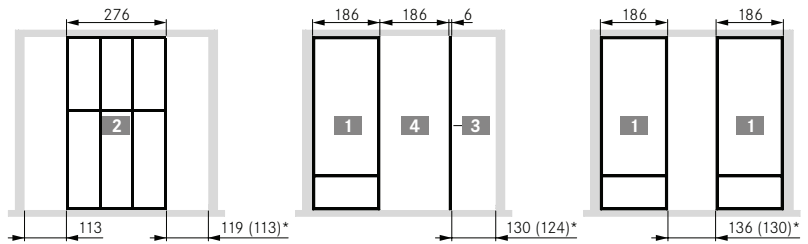
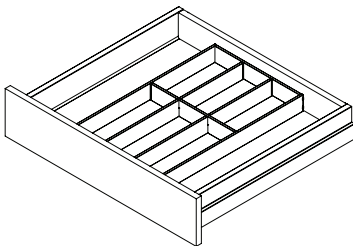

KB 900

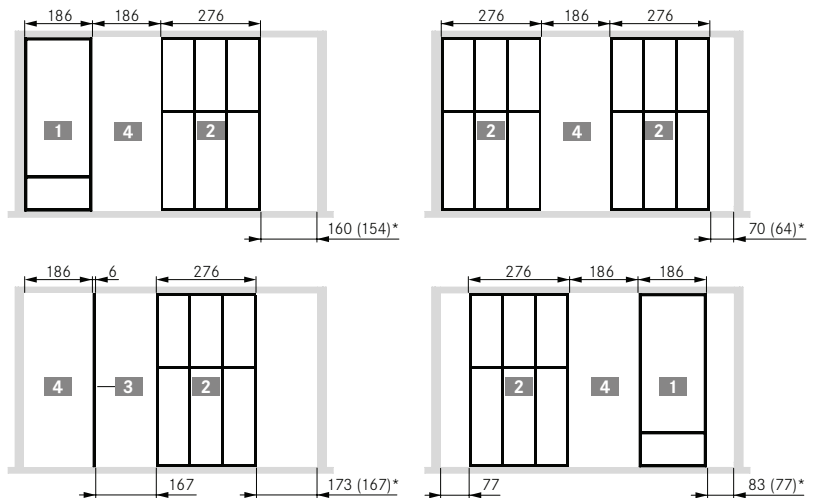
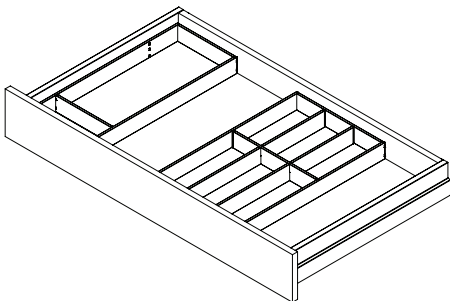

KB 1200

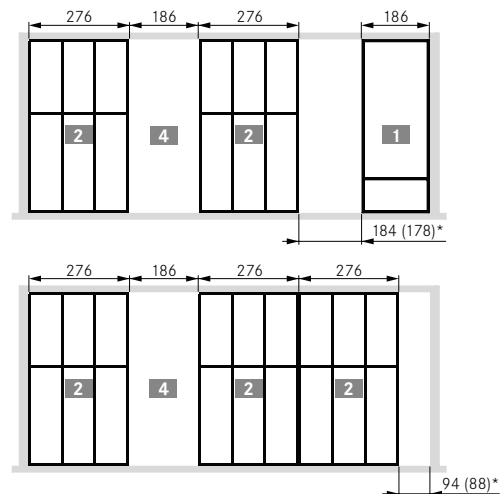
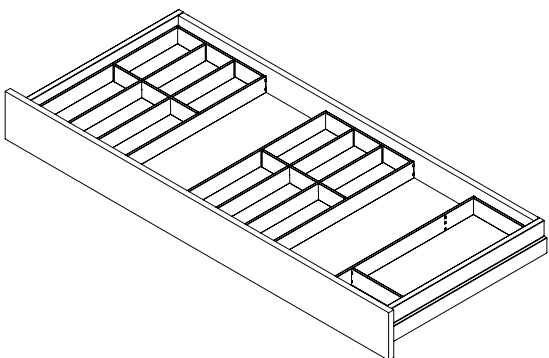

* S16 (S18/S19)

APPLICATION EXAMPLE

Description

1

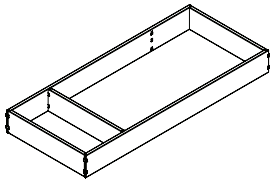

2

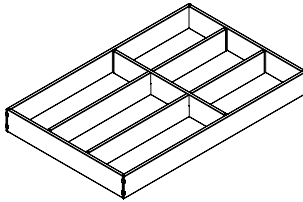

3

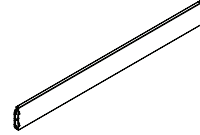

4

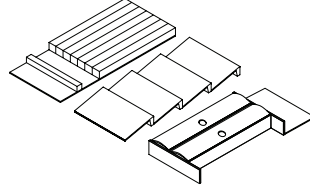

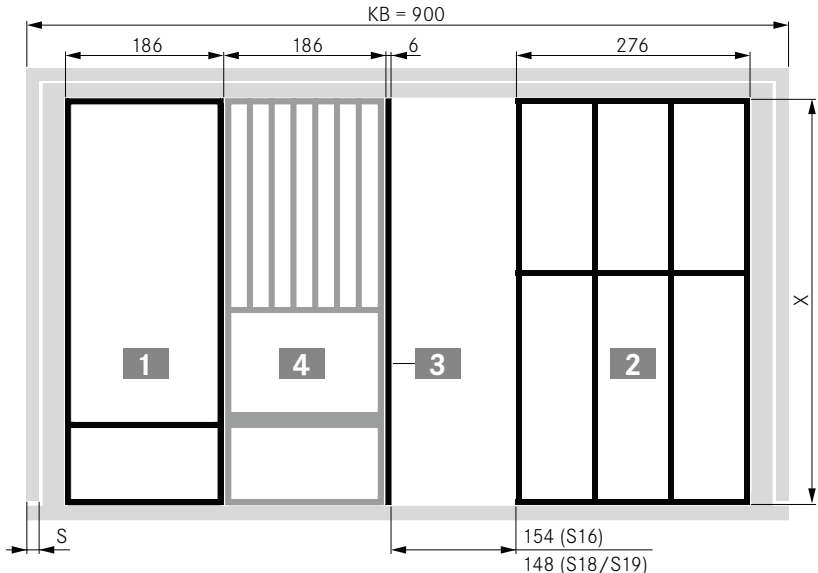

NL	X
350	329
400	379
450	429
500	479
550	530
600	580
650	630

INSTALLATION INFORMATION

Description

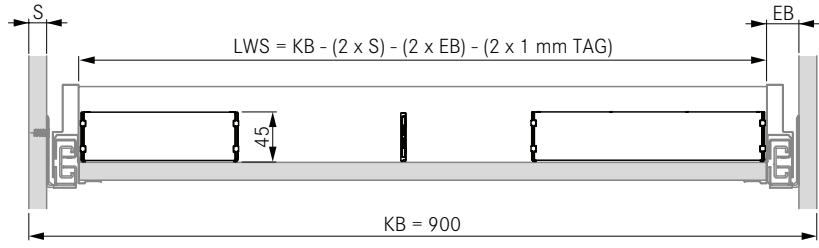

S/EB	External cabinet width (KB)										
	300	400	500	600	700	800	900	1000	1100	1200	
16/29	208	308	408	508	608	708	808	908	1008	1108	
18/30	202	302	402	502	602	702	802	902	1002	1102	
19/29	202	302	402	502	602	702	802	902	1002	1102	
Internal dimension (LWS)											

LEGEND

<p>EB Construction width</p> <p>KB Cabinet width</p> <p>LWS Clear drawer width</p> <p>NL Nominal length</p>	<p>S Cabinet side wall</p> <p>TAG Tolerance compensation</p>	
---	--	--