

Basic

Flap door hinge

For wooden doors

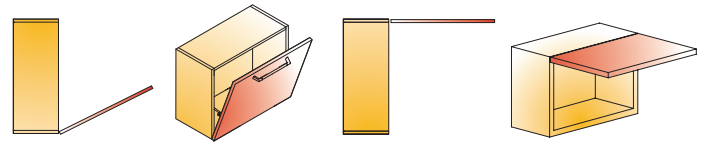
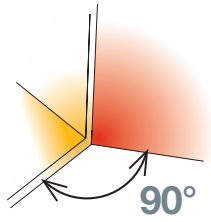

Cranking
0mm

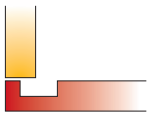

Interaxis
24mm

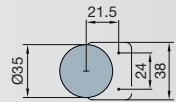

Cup
type

Item
number

left



926.0A26.050

right



926.0A27.050

200 Pcs

Made of steel

Hinge cup screws
If not pre-mounted

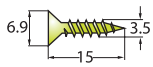

820.6308.050

200 Pcs



Legend of hinge cup symbols



Screw-on
← screws

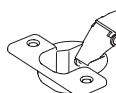

- Opening angle 90°
- Mounted on the cabinet side 35mm
- Standard drillings 11,5mm
- Hinge on plate mounting mechanisms slide-on

- To be used with flap stay mechanisms
- Mounted on the cabinet side
- Standard drillings

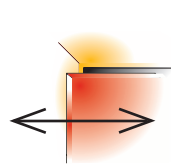

Side adjustment
+0.5/-0.5mm

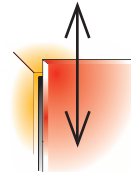

Height adjustment
+2/-2mm

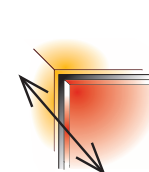

Depth adjustment
+4/-0mm

For further explanation → see pages 3.15 - 3.17

Mounting details

Mounting plate thickness table
For further explanation → see page 3.8

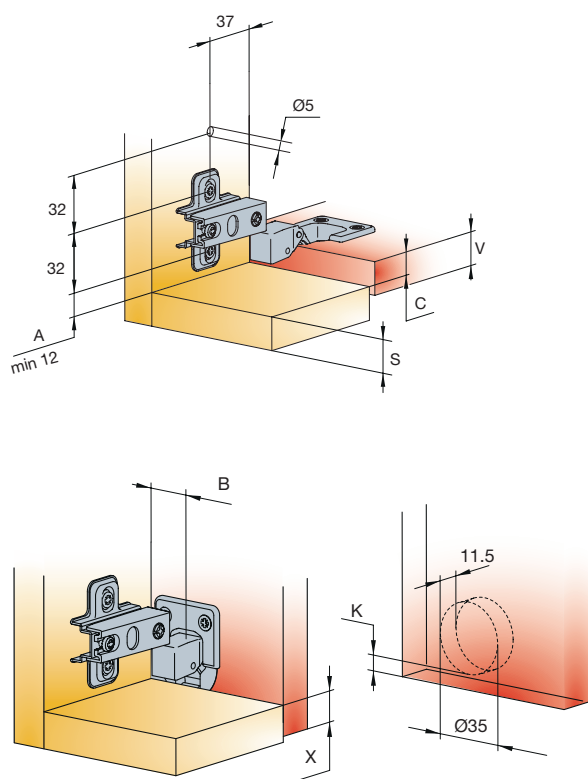

D	0	1	2	3
B (mm)	20	21	22	23

D=mounting plate height
K=B-6
X=A+K+10

Mounting plates



Steel mounting plates
→ see page 3.75



Zinc diecast mounting plates
→ see page 3.75

Accessories



Cover caps for hinge arm with Glissando
→ see page 3.101

Door clearance

V	16	17	18	19	20	21	22	
3	0.3	0.5	0.7	1.0	1.3	1.7	2.5	
K	4	0.3	0.5	0.7	0.9	1.2	1.6	2.1
5	0.3	0.5	0.7	0.9	1.2	1.5	2.0	F _{MIN}

Gap Z_{MIN}=0

Basic

Mounting plates

For Basic concealed hinges

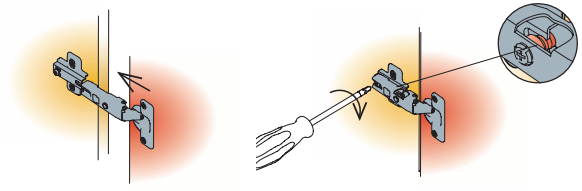

Drilling pattern

Dimensions

Steel mounting plates

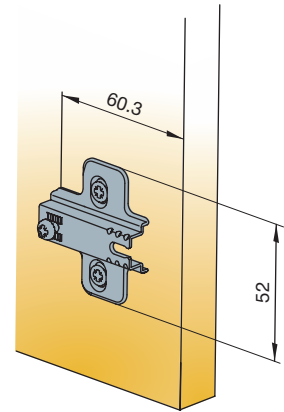
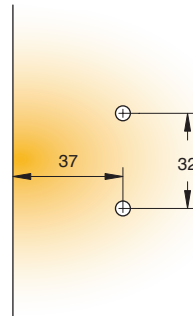

200 Pcs

Made of steel

Zinc diecast mounting plates

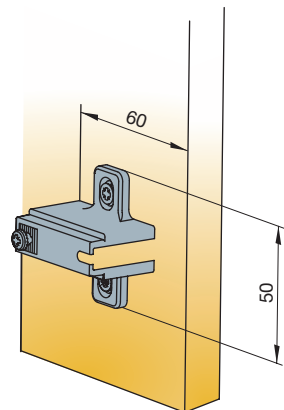
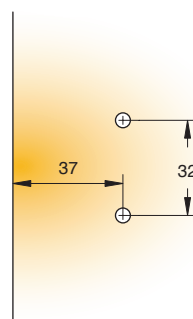

200 Pcs

Made of zinc

Fixing screws for mounting plates
If not pre-mounted

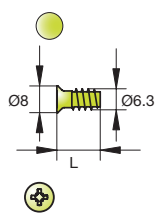

Euro screws
821.6304.050 L=11
821.6323.050 L=13
821.6332.050 L=15

5000 Pcs

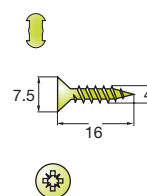

Chipboard screws
820.6328.050

1000 Pcs

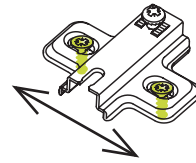
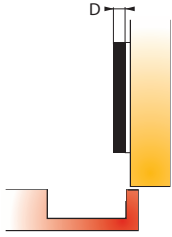

Mounting plate thickness

Height adjustment +/- 2mm

Mounting plate type									
Mounting plate thickness (D)									
Item number									
0mm	244.0866.050	*244.0L29.050	244.0963.050	244.0965.050	244.0929.050	*244.0L26.050	*244.0L50.050	244.0H64.050	244.0P24.050
1mm	244.0T40.050		244.0307.050	244.0K95.050		*244.0S65.050		244.0S67.050	
2mm	244.0T28.050		244.0Z64.050	244.0K96.050		*244.0S66.050	*244.0V64.050	244.0S68.050	
3mm	244.0867.050	*244.0L39.050	244.0L66.050	244.0G19.050	244.0930.050	*244.0L98.050	*244.0L40.050	244.0H65.050	244.0P25.050
* Available upon special request → see page 0.3									
4mm	244.0L37.650			244.0K97.650				244.0M28.650	
5mm	244.0L38.650			244.0K98.650	244.0T14.650			244.0M29.650	
6mm	244.0232.650			244.0914.650			*244.0B12.650		
9mm	244.0062.650			244.0067.650	244.0P41.650				
18mm	244.0063.650			244.0068.650	244.0175.650				
* Available upon special request → see page 0.3									

Legend of mounting plate type symbols

- Screw on ready for euro screws
← screws
- Screw on ready for chipboard screws
- Pre-mounted 11mm euro screws
- Pre-mounted 13mm euro screws
- Pre-mounted 15mm euro screws
- Pre-mounted chipboard screws
- Machine insertion ready
- Premounted 7.5mm expanding dowels
- Pre-mounted 10.5mm expanding dowels

