

# Nova Pro

## Installation

### S18323 Nova PRO DL drawer 400mm H=122mm set

G65156 Decor Nova PRO DL 400mm,h=122mm metallic	1 pair
G63666 Cab.member PRO 400mm, 40kg load capacity, full extension	1 pair
G27330 Cover cap for Nova PRO DL&CL adjustment screws, anthrazit	2 pcs
G25821 U-cover for Nova PRO DL&CL decors, metallic	2 pcs
G21854 Installation hook for Nova PRO, dowelled version	2 pcs

### Installation measurements for Nova Pro Deluxe and Classic

#### Technical information

Installation measurement  $58 \pm_{0}^{0.5}$   
 Tolerance adjustment  $\pm 1$  mm  
 Bottom panel thickness 16 mm  
 Drawer slide mounting:  
 Euro screw dia. 6 mm x 13 mm  
 Drill depth - 13 mm

#### Assembly:

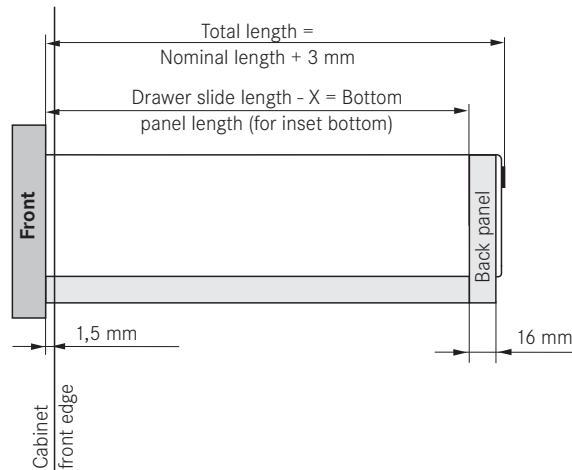

#### Dimension X

Wooden - back panel X = 19 mm
Steel - back panel X = 13 mm

### Screw position for Nova Pro 40 kg and Nova Pro 70 kg

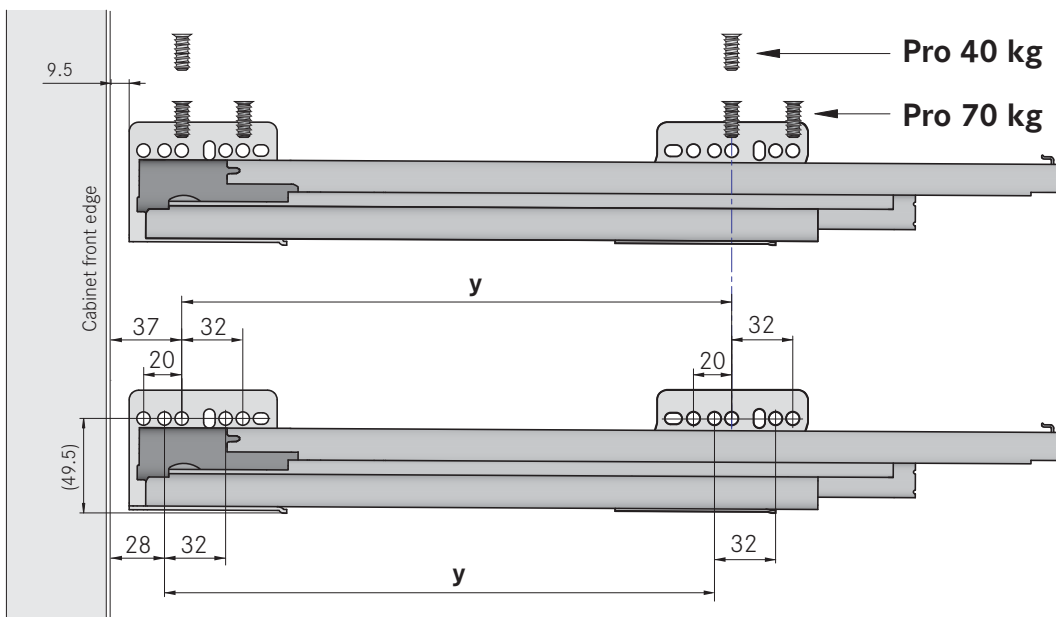

	Drawer length			
	270 mm	300 - 400 mm	450 - 600 mm	650 mm
Measurement y	160 mm	224 mm	288 mm	352 mm

If the chipboard quality corresponds to the resistance to axial withdrawal of screws described in DIN EN 320 (>1.000 N), we recommend using the  $\emptyset 6 \times 13$  mm standard Euro screw for fastening according to the pattern shown above. Fastening methods which differ from the specification are to be tested by the furniture manufacturer

### Installation measurements for Nova Pro Deluxe, Classic and Crystal

#### Dimensional sketch

**Height 63 mm**  
Classic

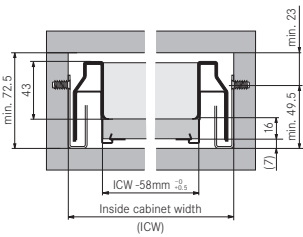

**Height 90 mm**  
Classic / Deluxe

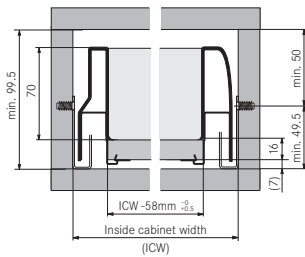

**Height 122 mm**  
Classic / Deluxe

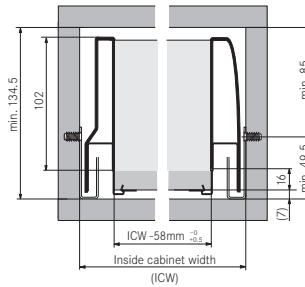

**Height 90 mm**  
Deluxe Crystal

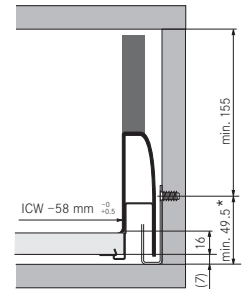

#### Front

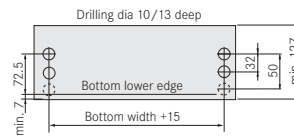
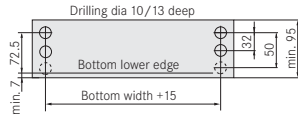
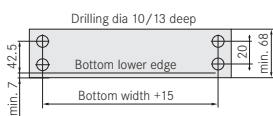

#### Glass:



#### Back panel

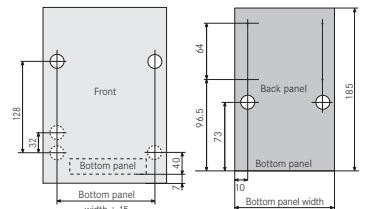
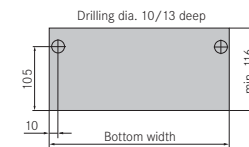
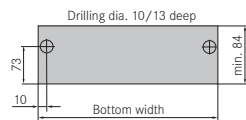
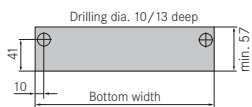

#### Height adjustment with eccentric screw

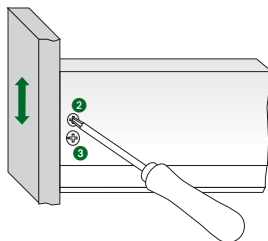

**Height adjustment:** Loosen screw ② slightly and position front at the required height by means of eccentric screw ③. Adjustment ± 2 mm. Tighten screw ②.

#### Side adjustment

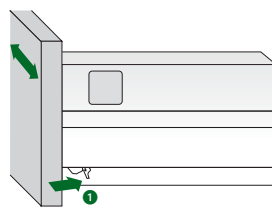

**Side adjustment:** Push clamping lever on both sides ① to the back slightly, slightly raise front and slide over ribs, adjustment ± 1.5 mm. Release clamping lever.

#### Tilt adjustment of front

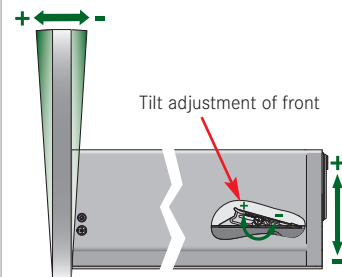

**New for drawer sides height 122**  
Readily accessible tilt adjustment facility on the inside of the drawer sides. The tilt adjustment is achieved by angling the drawer (± 2mm).

\* If Nova Pro Crystal is used for internal fronts (front FL) = min. 52.5 mm

# Nova Pro - General Information



## Benefits for your assemblers

### Simple installing and removing

The Nova drawers can be installed or removed with just one movement (with no levers to press).

#### Front installation + removal (tool-free)

The drawer front panel can be attached or removed with one movement. Simple and tool-free!



#### Assembly

1. Angle the front panel with the installation hooks into the lower slanted slot. (0-positioning with the installation hooks).
2. Tilt the front in and...
3. ...Press down.

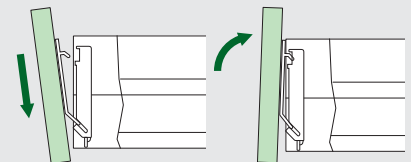

#### Removing

1. Press the catch 1 and ...
2. ... Remove front panel.

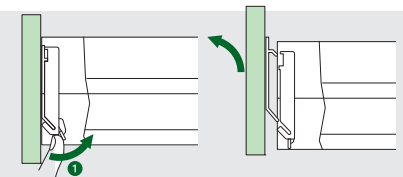

### Installation

#### Tool-free side adjustment

1. Press the catch hooks 2 (left and right) to the back.
2. Lift the front up slightly and slide over the ribs.

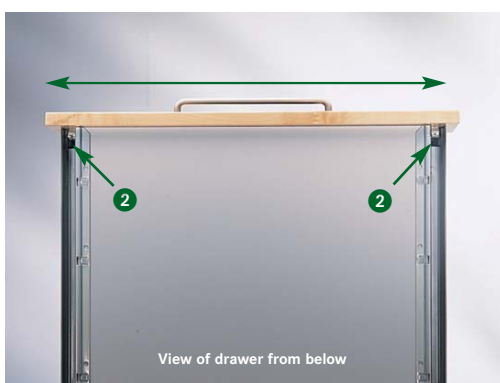

#### Height adjustment

Slightly loosen screw 3 and slide the front with the eccentric screw 4 into the desired height position. Adjustment range  $\pm 2$  mm. Tighten screw 3.



#### Tilt adjustment of front

##### New for drawer side height 122 mm

Readily accessible tilt adjustment facility on the inside of the drawer side. The tilt adjustment is achieved by angling the drawer.

