

KINVARO

T-71 lift-up flap fitting



- Variable opening angle - holds flap securely at any angle between 45° and 110°
- Extremely comfortable opening thanks to spring-supported opening mechanism
- Adjustable spring force
- Integrated adjustable closing damper
- Flap 3-dimensionally adjustable - height, side, angle: direct adjustment ± 1.5 mm
- No hinges fitted to the top panel
- Allows additional cabinet installation above
- Can be used for wooden flaps or aluminium frames with glass infill
- Fast, tool-free clip fitting of the front
- Weight 1.4 to 8.5 kg
- Range of flaps:
Width: up to 1200 mm
Height: 300 – 600 mm
- Cover caps in white and grey, similar to RAL 7045

APPLICATION RANGE

Cabinet height	Flap weight incl. handle (kg)	
	Spring, white	Spring, orange
300	2.1 – 7.4	2.5 – 8.5
350	1.8 – 6.3	2.3 – 7.5
400	1.7 – 5.4	2.1 – 6.8
450	1.6 – 4.7	2.0 – 5.8
500	1.5 – 4.0	1.8 – 5.0
550	1.4 – 3.7	1.6 – 4.6
600	1.4 – 3.3	1.4 – 4.2

ORDER INFORMATION

Kinvaro T-71 set

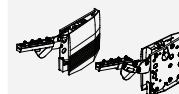

Designation	Springs	Version for	Overlay	Art.-no.	
				Cover cap white	Cover cap grey
Kinvaro T-71 on right without damper and on left with damper, pre-assembled springs white, incl. cover caps, 2 loose orange springs	white/orange	wood	variable	F151147811	F151147696

Aluminium frame adapter, Kinvaro T-71 set



Designation	Overlay	Art.-no.
Aluminium frame adapter (2x) for narrow aluminium frames (19 mm) with fixing screws (16x)	13 – 17	F151145226

Kinvaro T-71 set comprises:

- 1** Fitting on the right without and on the left with damper (1x)
- 2** Cover caps on right and left (1x)
- 3** Mounting plates (2x)
Springs, orange, loose (2x)
Paper template (1x)
Installation instructions (1x)

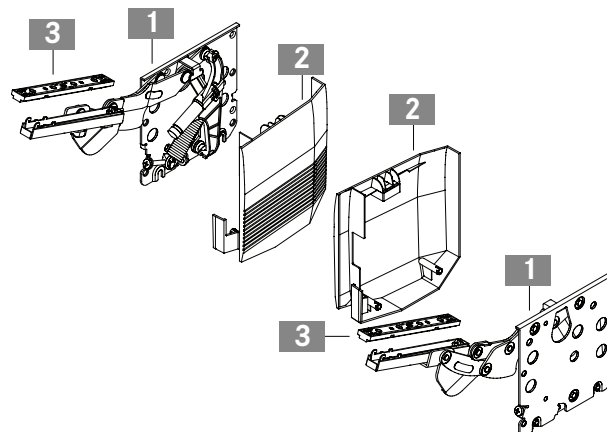

Assembly aids	50		
Kinvaro T-71 adjustment options	42		

ASSEMBLY AND INSTALLATION INSTRUCTIONS

All dimensions in millimetres

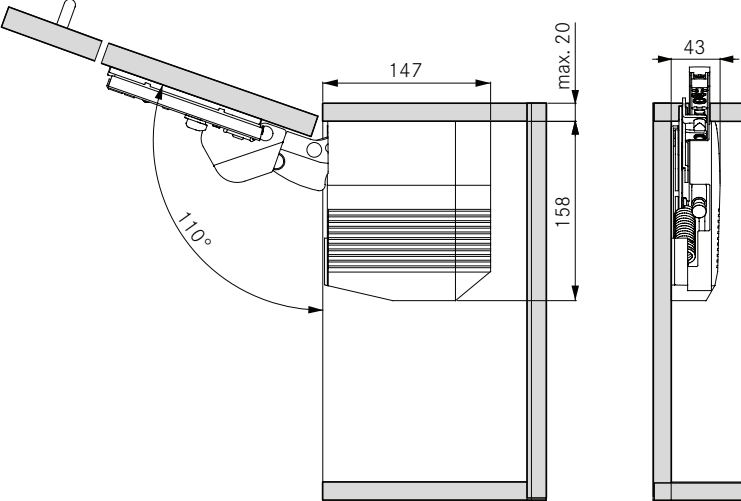
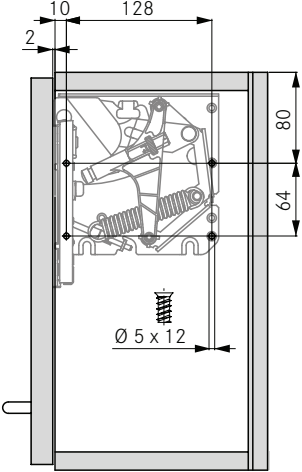
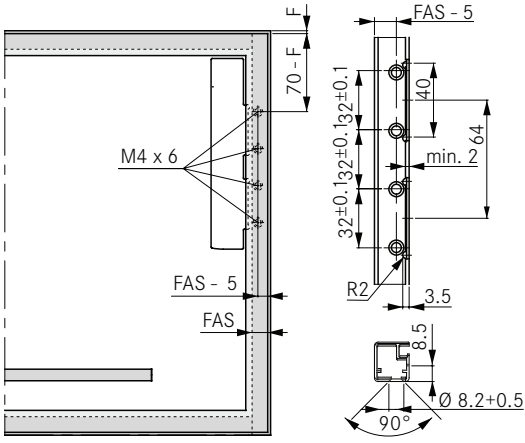
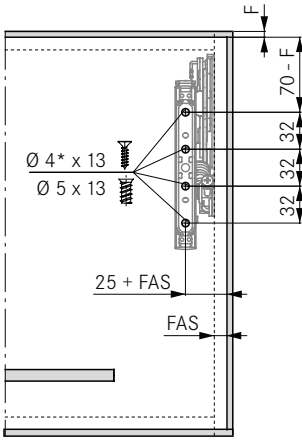
<p>Required space</p> 	<p>Side wall drilling positions</p> 
<p>Front: installation for flaps with standard aluminium frame profiles (19 mm)</p>  <p>* Standard aluminium frame profile (19 mm)</p>	<p>Front: installation for wooden and frame flaps (min. 55 mm width)</p>  <p>* Pre-drilling required - Ø 2 mm</p>
<p>Calculation of flap weight</p> <p>Flap width x flap height x flap thickness x density¹ + weight of handle² = weight of flap</p> <p>¹ Densities: MDF 0.85 kg/dm³, chipboard 0.65 kg/dm³, spruce/pine 0.45 kg/dm³</p> <p>² For bar handles allow 0.1 kg for each 100 mm handle width. We recommend a trial fitting</p>	

WARNING

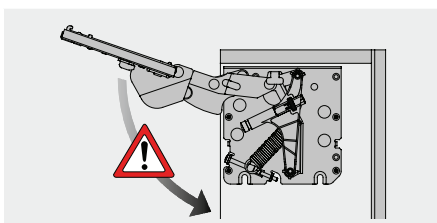

Important!
Caution - risk of injury!
Fitting is spring-tensioned!

LEGEND

F Reveal
FAS Front overlay, side