

KINVARO

T-75 lift-up flap fitting



- Variable opening angle - holds flap securely at any angle between 45° and 110°
 - Extremely comfortable opening thanks to spring-supported opening mechanism
 - Adjustable spring force
 - Integrated adjustable closing damper
 - Adjustable flap height ±2.0 mm
 - No hinges fitted to the top panel
 - Allows additional cabinet installation above
 - Can be used for wooden flaps or aluminium frames with glass infill
 - Weight 5.2 to 11.0 kg
- Range of flaps:
Width: up to 1200 mm
Height: 400 – 600 mm
 - Cover caps in white and grey, similar to RAL 7045

APPLICATION RANGE

Cabinet height	Flap weight incl. handle (kg)
	Spring, standard
400	7.0 – 11.0
450	6.7 – 9.6
500	5.8 – 8.5
550	5.6 – 7.6
600	5.2 – 7.0

ORDER INFORMATION

Kinvaro T-75 set

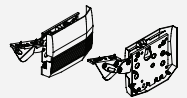

Designation	Springs	Version for	Overlay	Art.-no.	
				Cover cap white	Cover cap grey
Kinvaro T-75 on right without damper and on left with damper incl. cover caps	standard	wood	variable	F151147700	F151147699
		aluminium	13	F151147813	F151147702
			14	F151147814	F151147703
			16	F151147815	F151147704
			17	F151147816	F151147705

Kinvaro T-75 set comprises:

- 1 Fitting on the right without and on the left with damper (1x)
- 2 Cover caps on right and left (1x)
Paper template (1x)
Installation instructions (1x)

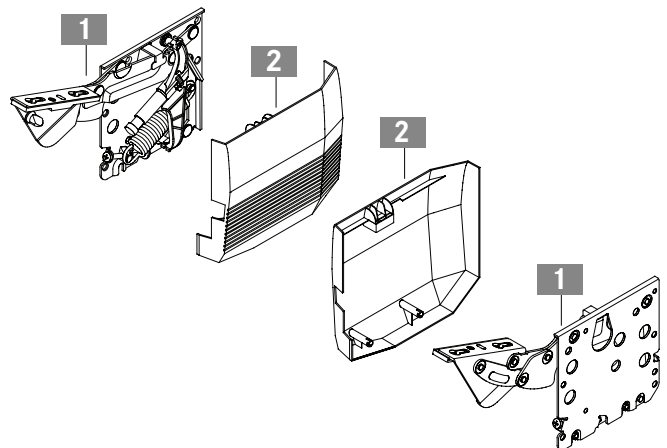

Assembly aids	50		
Kinvaro T-75 adjustment options	43		

ASSEMBLY AND INSTALLATION INSTRUCTIONS

All dimensions in millimetres

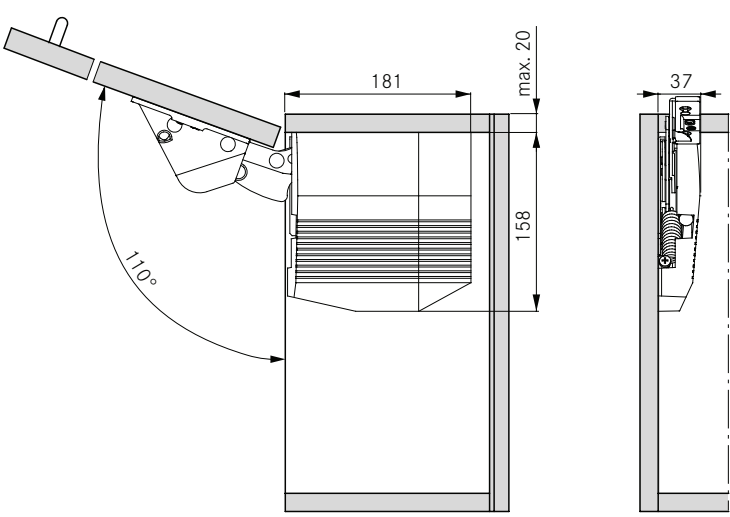
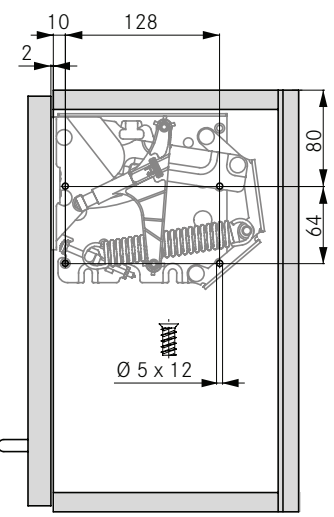
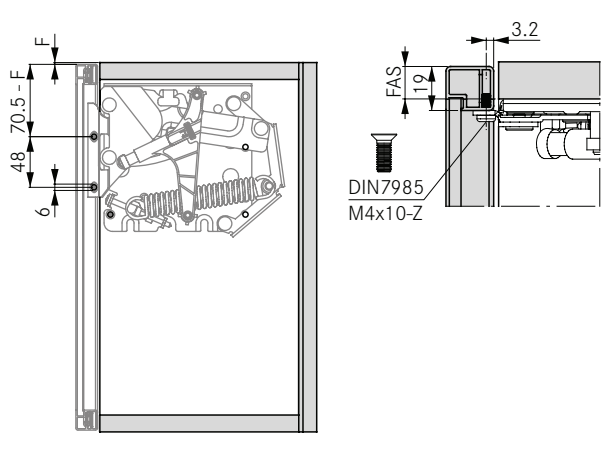
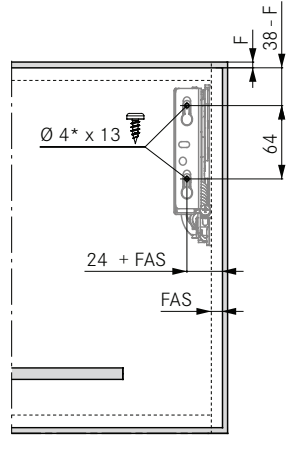
<p>Required space</p> 	<p>Side wall drilling positions</p> 
<p>Front: installation for flaps with standard aluminium frame profiles (* 19 mm)</p> 	<p>Front: installation for wooden and frame flaps (min. 55 mm width)</p>  <p>* Pre-drilling required - Ø 2 mm</p>
<p>Calculation of flap weight</p> <p>Flap width x flap height x flap thickness x density¹ + weight of handle² = weight of flap</p> <p>¹ Densities: MDF 0.85 kg/dm³, chipboard 0.65 kg/dm³, spruce/pine 0.45 kg/dm³</p> <p>² For bar handles allow 0.1 kg for each 100 mm handle width. We recommend a trial fitting</p>	

WARNING

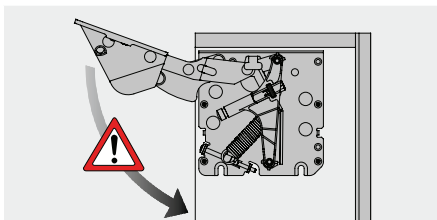

Important!
Caution - risk of injury!
Fitting is spring-tensioned!

LEGEND

F Reveal
FAS Front overlay, side