

VERSAHIT dual

Modulo cablato a scomparsa con sportelli scorrevoli |
Powerdock with independent sliding covers

SCHEDA TECNICA | DATA SHEET

ED.20_13.04.2026

VERSAHIT dual

Modulo cablato a scomparsa con sportelli scorrevoli |
Powerdock with independent sliding covers



DATI COMMERCIALI | COMMERCIAL DATA

Codice prodotto Product code	060.15	Codice famiglia di prodotto - Valido per tutte le configurazioni Family product code - Valid for all configurations
---------------------------------	--------	--

DATI TECNICI | TECHNICAL DATA





GENERALE | GENERAL

Tensione nominale Rated voltage	110 - 250 V ac, 50 Hz	
Corrente nominale Rated current	10 - 16A	
Grado di protezione Degree of protection	IP54	A coperchi chiusi With closed covers
Ambiente di utilizzo Operating environment	Interno Indoor	

MATERIALI | MATERIALS

Corpo Body	Tecnopolimero autoestinguente Flame retardant polymer
Cornice e sportelli Frame and covers	Zama Zamak
Prese elettriche Electric Sockets	Tecnopolimero autoestinguente Flame retardant polymer









PRESE ELETTRICHE | ELECTRIC SOCKETS

Tipo Type	B - E - F - J - H, 2P+T, con otturatori (protezione bimbi) B - E - F - J - H, 2P+T, with shutters (child protection)				
	 B	 E	 F	 J	 H
Vtaggio Rated voltage	220 - 250 V ac, 50 Hz	Presenza tipo I Socket type	E - F - H - J - P30		
	110 - 125 V ac, 60 Hz	Presenza tipo I Socket type	B		
Corrente Rated current	16 A	Presenza tipo I Socket type	E - F - H - P30		
	12 A	Presenza tipo I Socket type	B		
	10 A	Presenza tipo I Socket type	J		
Carico massimo complessivo Max.load power	3400W	Presenza tipo I Socket type	E - F - H - P30		
	2200W	Presenza tipo I Socket type	J		
	1200W	Presenza tipo I Socket type	B		

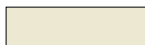
PORTE USB DA RICARICA | USB CHARGING PORT

Ingresso Input	100 - 240 V ac, 0,5A		
Uscita Output	USB A+C	USB C: 5V 2.4A, 12 W (condiviso tra USB A e USB C / shared between USB A and USB C) (ricarica standard / standard charging)	
Compatibilità Compatibility	Tutti smartphone, tablet e altri dispositivi ricaricabili (fotocamere, auricolari, ecc.) All smartphones, tablets and other USB chargeable devices (cameras, headset etc.)		

FINITURE | FINISHES

Cornice e sportelli Frame and covers			
	Acciaio spazzolato Stainless steel		Bronzo Bronze
	Champagne Champagne		Peltro Pewter
	Oro Gold		Nero opaco Matt black
	Bianco opaco Matt white		Rame Copper



NOTE | NOTES

- Disponibili a richiesta altre finiture.
- Uso solo in ambienti interni.

Significato per la protezione IP 54: a coperchi chiusi, la penetrazione di polveri e liquidi non danneggerà l'apparecchiatura.

Prima cifra caratteristica indica il grado di protezione contro l'accesso a parti pericolose e contro i corpi solidi estranei.

5* Protetto contro la polvere» protezione totale contro la penetrazione di corpi solidi.

Seconda cifra caratteristica indica il grado di protezione contro l'acqua. 4* Protezione contro la penetrazione di acqua spruzzata sull'involucro da tutte le direzioni.

* Il grado di protezione del prodotto è garantito solo a coperchi chiusi.

- Attenzione: Il prodotto è stato studiato per drenare l'acqua che accidentalmente può essere rovesciata sopra (a coperchi chiusi), per questo motivo assicurarsi che il fondo dell'alloggiamento del prodotto sia sempre libero affinché possa fuoriuscire l'acqua presente all'interno.

- Prestare particolare cura nella fase di installazione in quanto il prodotto non è previsto con un vaschetta raccogli acqua quindi non deve essere posizionato nelle zone dove l'acqua drenata sottostante può provocare dei danni.

- Se il prodotto viene montato in zone a rischio di contatto con l'acqua, bisogna applicare del silicone o sigillanti similari sul piano dove appoggia la cornice.

- L'apparecchio deve essere collegato ad una presa principale correttamente installata e provvista di collegamento a terra in accordo alle norme vigenti.

- Other finishes available upon request.
- Indoor use only.

Meaning for the protection IP54: With closed covers, the access of dust and liquids will not damage the device.

First characteristic numeral indicates the degree of protection against access to hazardous parts and against solid foreign objects.

5* Protected against dust» Total protection against access of solid foreign objects.

Second characteristic numeral indicates the degree of protection against water.

4* Protection against ingress of water splashed on the housing from all directions.

* The IP protection degree is guaranteed only with closed lids

- Warning: The product was designed to drain water that may be accidentally spilled over (when the lids are closed), for this reason make sure that the bottom side of the housing of the product is always free so that it can drain the water inside.

- Pay particular care during installation because the product is not provided with a water collecting tray so should not be placed in areas where the drained water below can cause damages.

- If the product is mounted in areas at risk of contact with water, it is necessary to apply silicone or similar sealants on the panel where the frame stands.

- This appliance must be connected to a main socket correctly installed and provided with ground connection in accordance with current norms.



RAEE - Rifiuti derivanti da Apparecchiature Elettriche ed Elettroniche. Questi prodotti devono essere riciclati in modo adeguato e non devono essere gettati fra i rifiuti domestici o nei rifiuti municipali indifferenziati.

WEEE - Waste of electric and electronic equipment. These products must be recycled properly and should not be disposed as household waste. Disposal in general household waste is prohibited.

Tutte le dimensioni indicate sono nominali. I disegni e le immagini sono solo a scopo illustrativo. I dettagli del prodotto e le dimensioni sono soggetti a modifiche senza preavviso.

All dimensions quoted are nominal only. Drawings and images are for illustrative purposes only. All product dimensions and specifications are subject to change without notice.

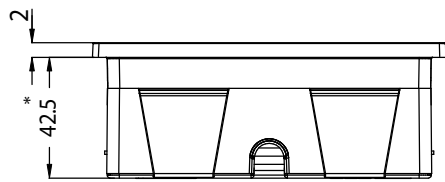



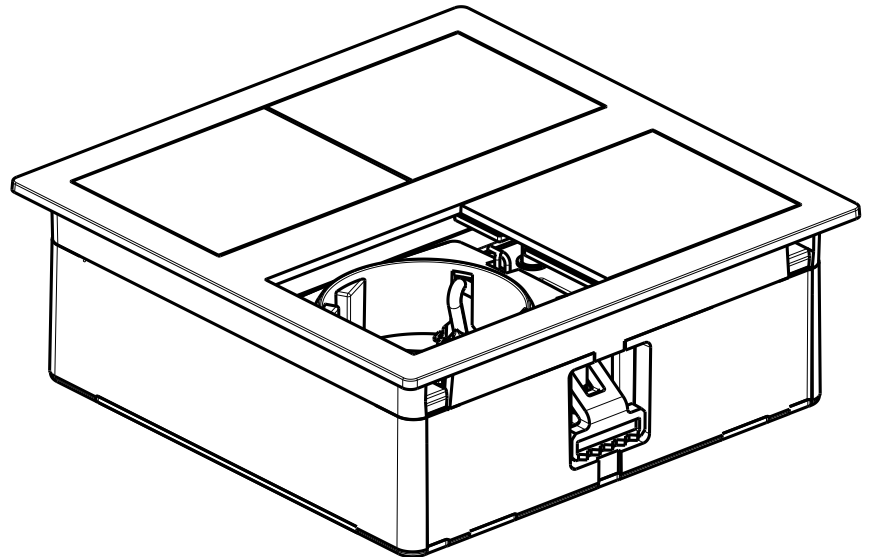
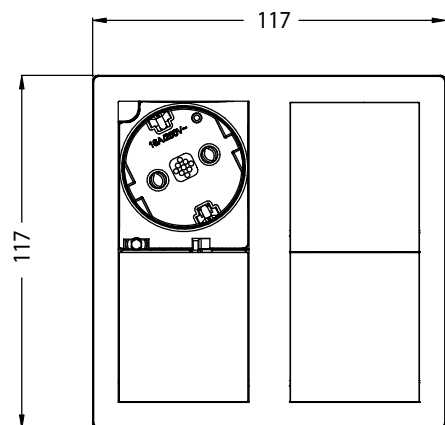



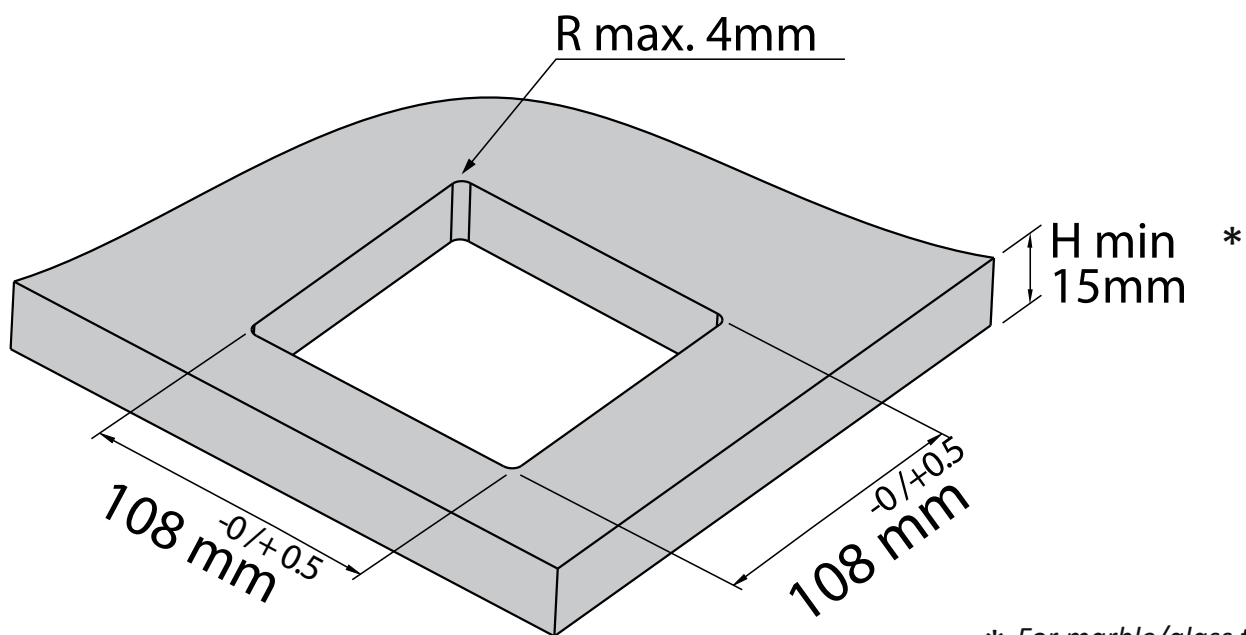



*presa svizzera 50 mm
*swiss socket



PIANO DI TAGLIO | CUT OUT DIMENSION

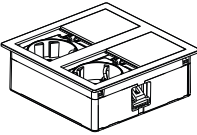
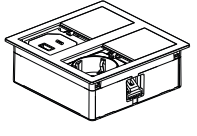

* For marble/glass tops: 15-20 mm

VERSAHIT DUAL					
PRESA SOCKET	  P30 (ITALY) *	  F (SCHUKO)	  E (FRENCH)		
	2 FRUTTI POWER 2 POWER SOCKETS			Cavo 2000 mm con spina separata 2000 mm cable / separated plug	
acciaio spazzolato stainless steel	060.15U.00001	060.15F.00001	060.15E.00001		
PREZZO PRICE					
champagne champagne	060.15U.00034	060.15F.00034	060.15E.00020		
PREZZO PRICE					
oro verniciato painted gold	060.15U.00003	060.15F.00003	060.15E.00003		
PREZZO PRICE					
bronzo bronze	060.15U.00004	060.15F.00004	060.15E.00004		
PREZZO PRICE					
peltro pewter	060.15U.00005	060.15F.00005	060.15E.00005		
PREZZO PRICE					
rame copper	060.15U.00046	060.15F.00046	060.15E.00046		
PREZZO PRICE					
bianco opaco matt white	060.15U.00008	060.15F.00008	060.15E.00008		
PREZZO PRICE					
nero opaco matt black	060.15U.00007	060.15F.00007	060.15E.00007		
PREZZO PRICE					
	1 FRUTTO POWER + 1 USB 5V (2 PORTE A+C) 1 POWER SOCKET + 1 USB 5V (2PORTS A+C)			Cavo 2000 mm con spina separata 2000 mm cable / separated plug	
acciaio spazzolato stainless steel	060.15U.00038	060.15F.00038	060.15E.00022		
PREZZO PRICE					
champagne champagne	060.15U.00039	060.15F.00039	060.15E.00023		
PREZZO PRICE					
oro verniciato painted gold	060.15U.00040	060.15F.00040	060.15E.00024		
PREZZO PRICE					
bronzo bronze	060.15U.00041	060.15F.00041	060.15E.00025		
PREZZO PRICE					
peltro pewter	060.15U.00042	060.15F.00042	060.15E.00026		
PREZZO PRICE					
rame copper	060.15U.00048	060.15F.00048	060.15E.00048		
PREZZO PRICE					
bianco opaco matt white	060.15U.00044	060.15F.00044	060.15E.00028		
PREZZO PRICE					
nero opaco matt black	060.15U.00045	060.15F.00045	060.15E.00029		
PREZZO PRICE					
NOTE NOTES					
DIM. L x H x W 390 X 280 X 320 mm		PESO WEIGHT 7,5 kg	PEZZI PER SCATOLA PCS PER BOX 8	MOQ 8 PZ / PCS	CODICE DOGANALE CUSTOM CODE 85366990
CAVI INCLUSI CABLES INCLUDED 2 metri / meters	 	CAVO ALIMENTAZIONE CON SPINA SEPARATA POWER CABLE FREE END PLUS SEPARATE PLUG			*PIANO DI TAGLIO DIFFERENTE- cavo escluso *DIFFERENT CUT OUT DIMEN- SION-cable not included

VERSAHIT